

Precision Adjustable Current Limited Power Distribution Switches

1 FEATURES

- **Typical 27µA Low Quiescent Current**
- **Typical 0.1µA Shutdown Current**
- **No Reverse Input-Output Leakage Current**
- **Meets USB Current Limiting Requirements**
- **Adjustable Current Limit: 400mA to 2.7A**
- **Fast Over-Current Response**
- **70mΩ High-side MOSFET**
- **Under Voltage Lockout**
- **Thermal Shutdown Protection**
- **Operating Range: 2.5V to 5.5V**
- **Built-In Soft-Start Function**
- **Available in the Green SOT23-5 Package**

2 APPLICATIONS

- **USB Host and Self-Powered Hubs**
- **USB Bus-Powered Hubs**
- **USB Power Management**
- **General Purpose Power Switch (High Side)**
- **Hot Plug-in Power Supplies**
- **Battery-Charger Circuits**

3 DESCRIPTION

The RS2582 is an integrated power switch for self-powered and bus-powered Universal Serial Bus (USB) applications.

The RS2582 is a cost-effective, low voltage, single P-channel MOSFET load switch with 70mΩ $R_{DS(ON)}$, which is free of parasitic body diode and has no reverse input-output leakage current. When the output voltage is higher than input voltage, the power switch is turned off by internal output reverse-voltage protector.

Several protection features include current limiting and thermal shutdown to prevent catastrophic switch failure caused by increasing power dissipation when continuous heavy loads or short circuit occurs.

RS2582 is available in the Green SOT23-5 package. It is rated over the -40°C to 85°C temperature range.

Device Information (1)

PART NUMBER	PACKAGE	BODY SIZE (NOM)
RS2582	SOT23-5	2.90mm×1.60mm

(1) For all available packages, see the orderable addendum at the end of the data sheet.

4 FUNCTIONAL BLOCK DIAGRAM

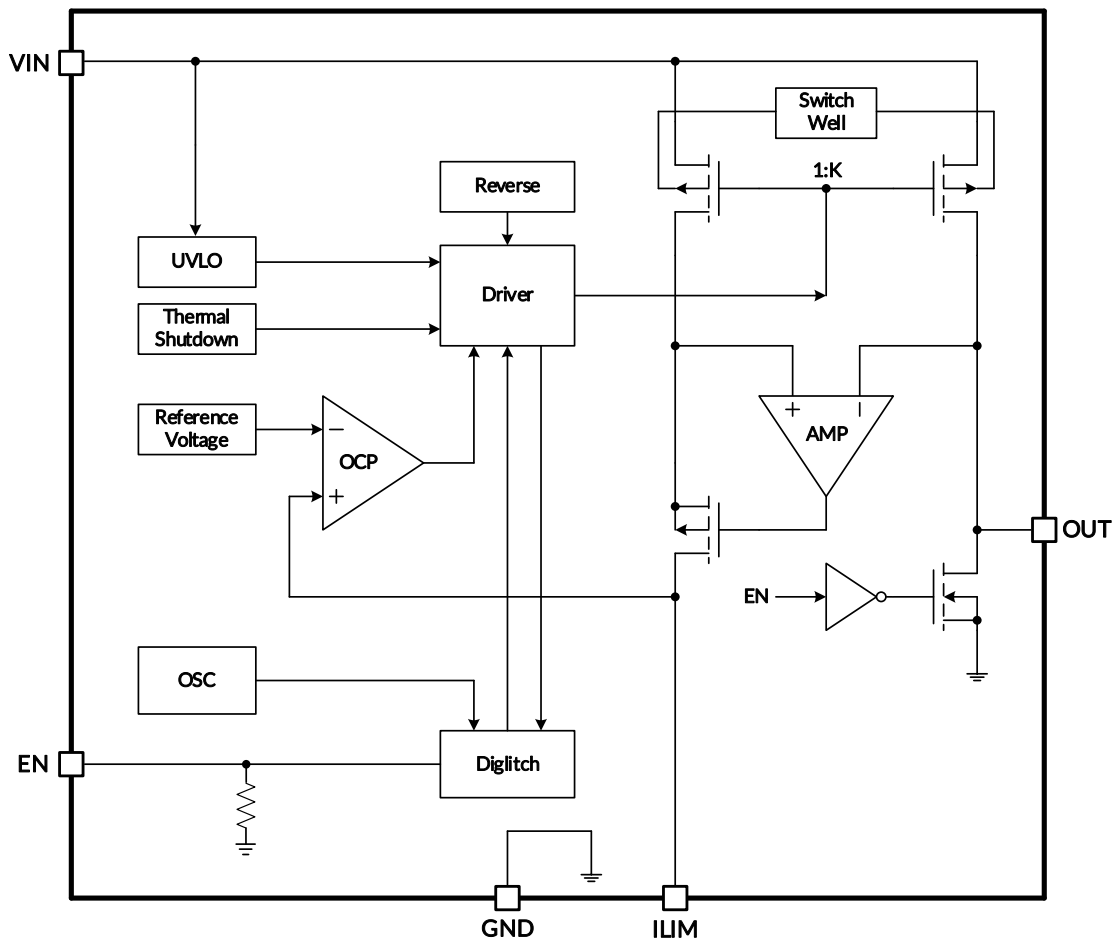

Table of Contents

1 FEATURES	1
2 APPLICATIONS	1
3 DESCRIPTION	1
4 FUNCTIONAL BLOCK DIAGRAM	2
5 REVISION HISTORY	4
6 PACKAGE/ORDERING INFORMATION ⁽¹⁾	5
7 PIN CONFIGURATIONS	6
8 SPECIFICATIONS	7
8.1 Absolute Maximum Ratings	7
8.2 ESD Ratings	7
8.3 Recommended Operating Rating	7
8.4 ELECTRICAL CHARACTERISTICS	8
8.5 PARAMETER MEASUREMENT INFORMATION	9
8.6 TYPICAL PERFORMANCE CHARACTERISTICS	10
9 DETAILED DESCRIPTION	12
9.1 Input and Output	13
9.2 Thermal Shutdown	13
9.3 Soft-Start	13
9.4 Under-Voltage Lockout (UVLO)	13
9.5 Current Limiting and Short-Circuit Protection	13
9.6 Reverse-Voltage Protection	13
9.7 Power Dissipation	13
9.8 Supply Filter Capacitor	14
9.9 Output Filter Capacitor	14
9.10 PCB Layout Guide	14
10 PACKAGE OUTLINE DIMENSIONS	15
11 TAPE AND REEL INFORMATION	16

5 REVISION HISTORY

Note: Page numbers for previous revisions may differ from page numbers in the current version.

VERSION	Change Date	Change Item
A.1	2023/08/18	Initial version completed
A.2	2024/11/04	1. Add MSL 2. Update ELECTRICAL CHARACTERISTICS and TYPICAL PERFORMANCE CHARACTERISTICS

6 PACKAGE/ORDERING INFORMATION ⁽¹⁾

PRODUCT	ORDERING NUMBER	TEMPERATURE RANGE	PACKAGE LEAD	PACKAGE MARKING ⁽²⁾	MSL ⁽³⁾	PACKAGE OPTION
RS2582	RS2582YF5	-40°C ~85°C	SOT23-5	2582	MSL3	Tape and Reel,3000

NOTE:

- (1) This information is the most current data available for the designated devices. This data is subject to change without notice and revision of this document. For browser-based versions of this data sheet, refer to the right-hand navigation.
- (2) There may be additional marking, which relates to the lot trace code information(data code and vendor code), the logo or the environmental category on the device.
- (3) RUNIC classify the MSL level with using the common preconditioning setting in our assembly factory conforming to the JEDEC industrial standard J-STD-20F, Please align with RUNIC if your end application is quite critical to the preconditioning setting or if you have special requirement.

7 PIN CONFIGURATIONS

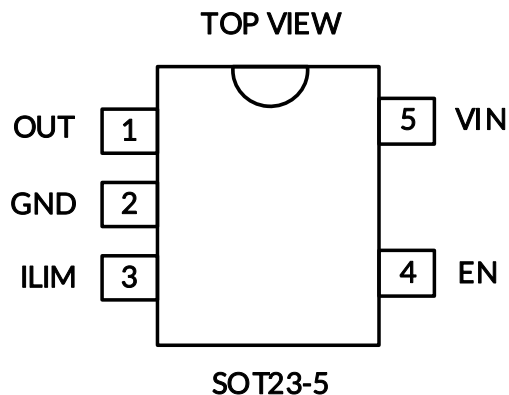

PIN DESCRIPTION

PIN	NAME	DESCRIPTION
SOT23-5		
1	OUT	Switch Output. The P-Channel Drain of Switch, Which Typically Connects to Load.
2	GND	Ground.
3	ILIM	Current limit set pin. Connect a resistor between this pin and ground to program the desired current limit set point. Do Not Float this PIN.
4	EN	Enable Input. Logic Level Enable Input, Active high available. Internal pulldown.
5	VIN	Power Supply Input. The P-Channel Source of Switch, Which also supplies IC's internal circuitry. Connect to Positive Supply.

8 SPECIFICATIONS

8.1 Absolute Maximum Ratings

over operating free-air temperature range (unless otherwise noted) ⁽¹⁾

		MIN	MAX	UNIT
V _{IN}	Supply voltage range	-0.3	6.0	V
V _{OUT}	Output voltage range	-0.3	6.0	V
V _{EN}	EN Input Voltage	-0.3	6.0	V
V _{ILIM}	ILIM Output Voltage	-0.3	6.0	V
P _D	Power Dissipation		0.3	W
θ _{JA}	Package thermal impedance ⁽²⁾	SOT23-5		200 °C/W
T _J	Junction temperature ⁽³⁾	-40	150	°C
T _{stg}	Storage temperature	-65	150	°C
T _L	Lead Temperature (Soldering,10secs)		260	°C

(1) Stresses beyond those listed under Absolute Maximum Ratings may cause permanent damage to the device. These are stress ratings only, and functional operation of the device at these or any other conditions beyond those indicated under Recommended Operating Conditions is not implied. Exposure to absolute-maximum-rated conditions for extended periods may affect device reliability.

(2) The package thermal impedance is calculated in accordance with JESD-51.

(3) The maximum power dissipation is a function of T_{J(MAX)}, R_{θJA}, and T_A. The maximum allowable power dissipation at any ambient temperature is P_D = (T_{J(MAX)} - T_A) / R_{θJA}. All numbers apply for packages soldered directly onto a PCB.

8.2 ESD Ratings

The following ESD information is provided for handling of ESD-sensitive devices in an ESD protected area only.

		VALUE	UNIT
V _(ESD) Electrostatic discharge	Human-body model (HBM), MIL-STD-883K METHOD 3015.9	±4000	V
	Charged-device model (CDM), ANSI/ESDA/JEDEC JS-002-2018	±1500	



ESD SENSITIVITY CAUTION

ESD damage can range from subtle performance degradation to complete device failure. Precision integrated circuits may be more susceptible to damage because very small parametric changes could cause the device not to meet its published specifications.

8.3 Recommended Operating Rating

		MIN	MAX	UNIT
V _{IN}	Supply voltage range	2.5	5.5	V
V _{OUT}	Output voltage range	0	5.5	V
V _{EN}	EN Input Voltage	0	5.5	V
V _{ILIM}	ILIM Output Voltage	0	5.5	V
I _{ILIM}	Output Current Limit	0.4	2.7	A
T _J	Junction temperature	-40	125	°C
T _A	Operating Temperature	-40	85	°C

8.4 ELECTRICAL CHARACTERISTICS

($V_{IN}=5.0V$, $T_A = +25^{\circ}C$, unless otherwise noted.) ⁽¹⁾

PARAMETER	SYMBOL	TEST CONDITIONS	MIN ⁽²⁾	TYP ⁽³⁾	MAX ⁽²⁾	UNIT
Power Input Voltage Range	V_{IN}		2.5		5.5	V
Power Supply Current	I_Q	Switch on, $V_{OUT}=\text{Open}$		27	50	μA
Shutdown Supply Current	I_{SD}	Switch off, $V_{OUT}=\text{Open}$		0.1	1.0	μA
Under-Voltage Lockout Threshold	V_{UVLO}	$C_{IN}=10\mu F$		1.9	2.4	V
Under-Voltage Lockout Threshold Hysteresis	V_{UVLO_HY}	$C_{IN}=10\mu F$		0.1	0.2	V
Switch Resistance	$R_{DS(ON)}$	$I_{OUT}=500mA$		70	80	$m\Omega$
Enable Input Threshold	V_{IH}	$V_{IN}=2.5V$ to $5.5V$, $C_{IN}=10\mu F$	1.6			V
	V_{IL}	$V_{IN}=2.5V$ to $5.5V$, $C_{IN}=10\mu F$			0.4	V
Enable Pull Down Resistance	R_{EN}	$V_{IN}=2.5V$ to $5.5V$		500		$k\Omega$
Output Turn-On Delay Time	t_{ON}	$C_{IN}=10\mu F$, $R_L=10\Omega$, $C_L=1\mu F$		2.0	3.0	ms
Output Turn-Off Delay Time	t_{OFF}	$C_{IN}=10\mu F$, $R_L=10\Omega$, $C_L=1\mu F$		20	50	μs
Response Time to Short Circuit	t_{SCR}	$C_{IN}=470\mu F$ to $1000\mu F$		6.0		μs
Current Limit Threshold	I_{LIMIT}	$C_{IN}=10\mu F$, $C_L=1\mu F$, $R_{LIM}=6.8K$	0.88	1	1.12	A
Short-Circuit Current Threshold	I_{SHORT}	$C_{IN}=10\mu F$, $C_L=1\mu F$, $R_{LIM}=6.8K$		0.75		A
OUT Shutdown Discharge Resistance	R_{DIS}	$C_{IN}=10\mu F$, Switch off		270	350	Ω
Thermal Shutdown Temperature	T_{SD}	$C_{IN}=10\mu F$		145		$^{\circ}C$
Thermal Shutdown Hysteresis	T_{SD_HY}	$C_{IN}=10\mu F$		20		$^{\circ}C$

(1) Electrical table values apply only for factory testing conditions at the temperature indicated. Factory testing conditions result in very limited self-heating of the device.

(2) Limits are 100% production tested at $25^{\circ}C$. Limits over the operating temperature range are ensured through correlations using statistical quality control (SQC) method.

(3) Typical values represent the most likely parametric norm as determined at the time of characterization. Actual typical values may vary over time and will also depend on the application and configuration.

8.5 PARAMETER MEASUREMENT INFORMATION

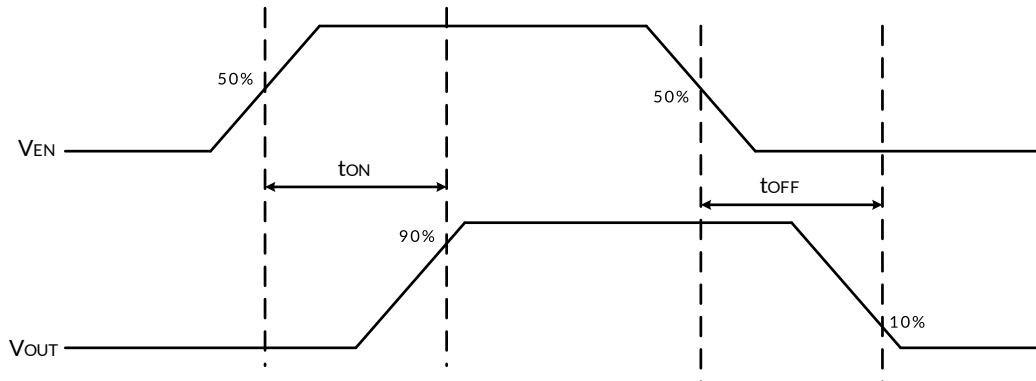

Figure 1. Switch Turn-On and Turn-Off Delay Time

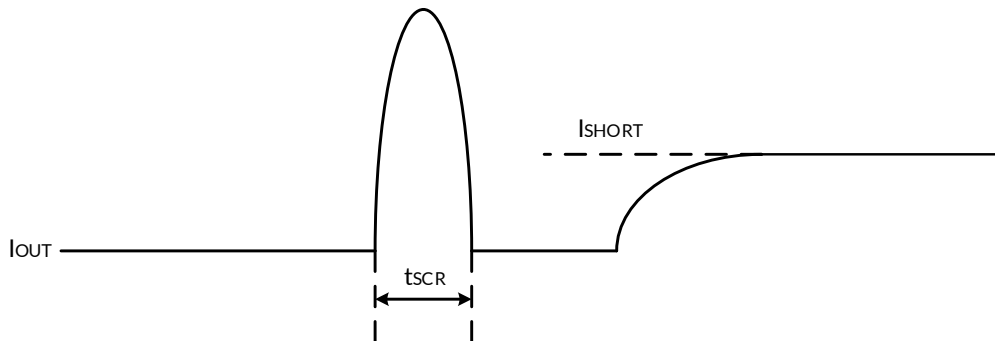

Figure 2. Short-Circuit Response Time

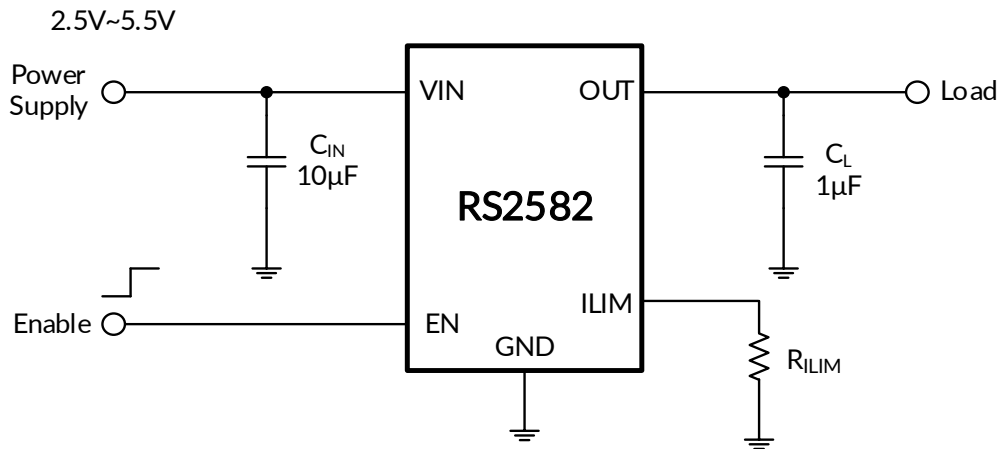

Figure 3. Typical Application Circuit

8.6 TYPICAL PERFORMANCE CHARACTERISTICS

NOTE: The graphs and tables provided following this note are a statistical summary based on a limited number of samples and are provided for informational purposes only.

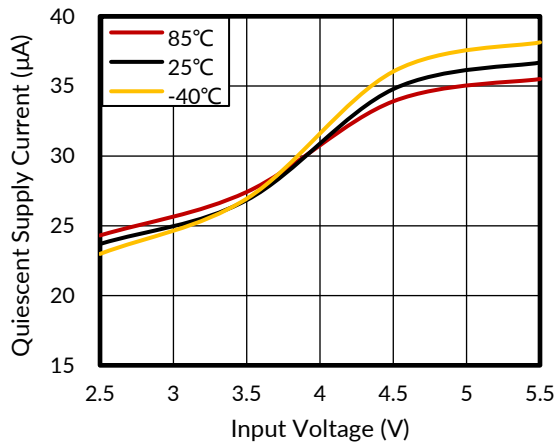

Figure 4. Quiescent Current vs Input Voltage

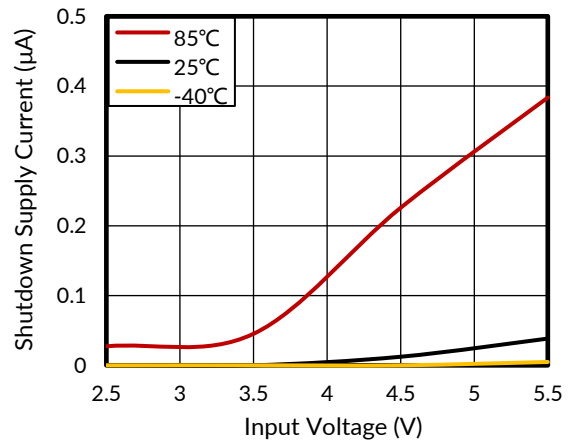

Figure 5. Shutdown Current vs Input Voltage

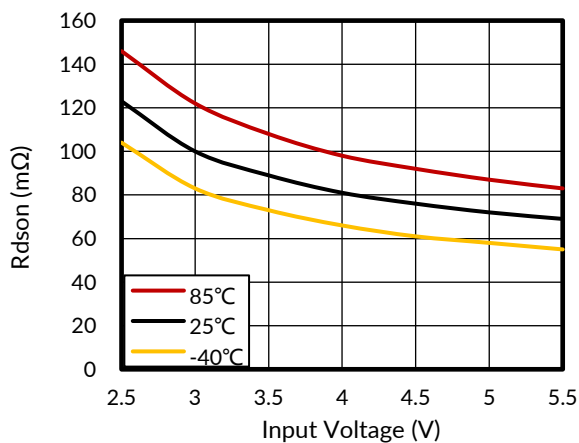

Figure 6. High-side MOSFET On Resistance vs Input Voltage

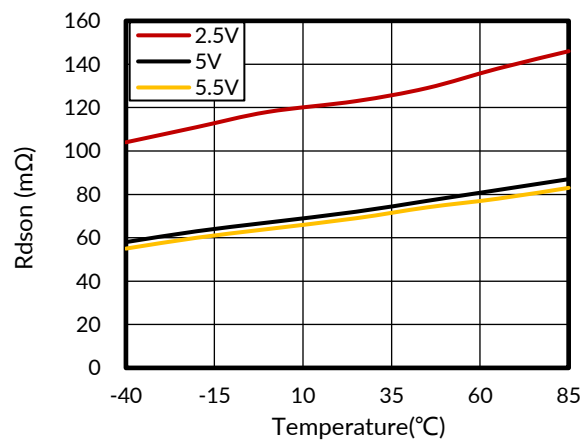

Figure 7. High-side MOSFET On Resistance vs Temperature

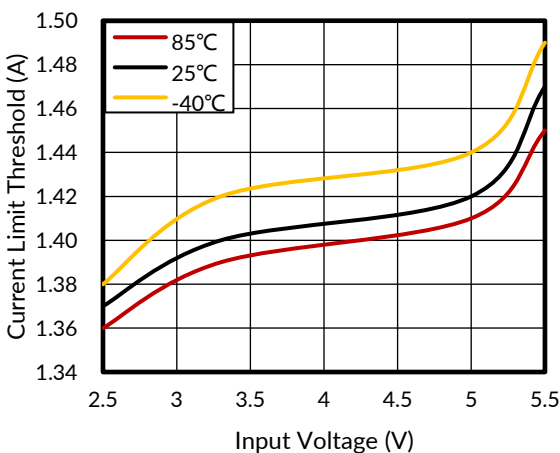

Figure 8. Current Limit Threshold vs Input Voltage

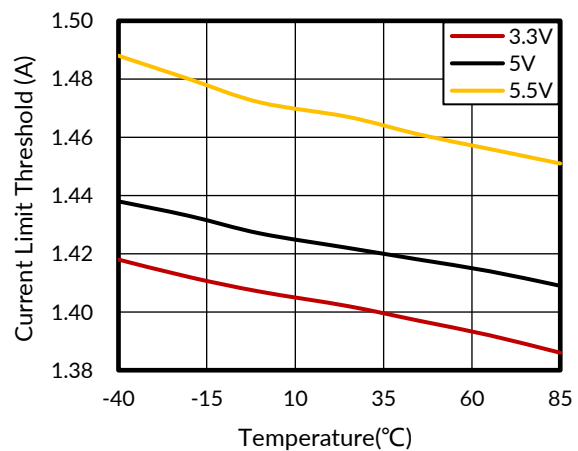

Figure 9. Current Limit Threshold vs Temperature

TYPICAL PERFORMANCE CHARACTERISTICS

NOTE: The graphs and tables provided following this note are a statistical summary based on a limited number of samples and are provided for informational purposes only.

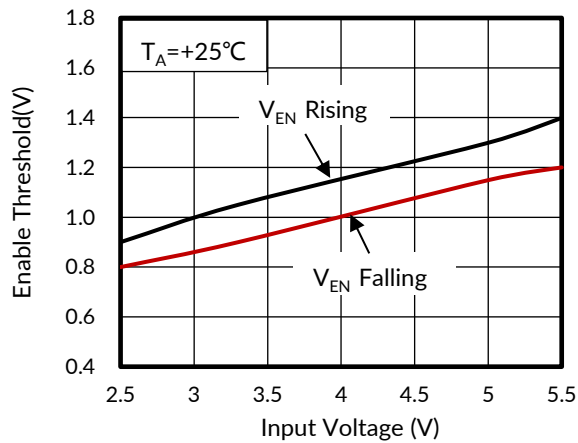

Figure 10. Enable Threshold vs Input Voltage

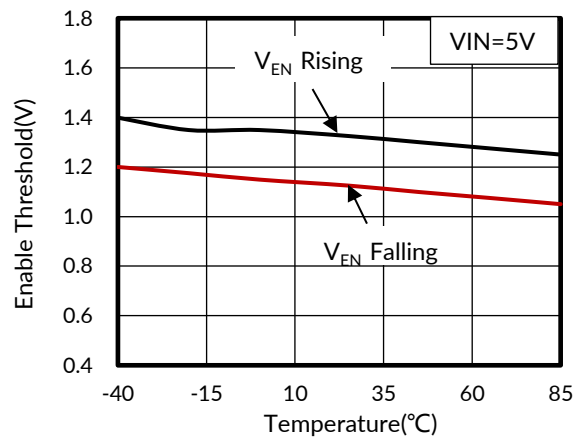

Figure 11. Enable Threshold vs Temperature

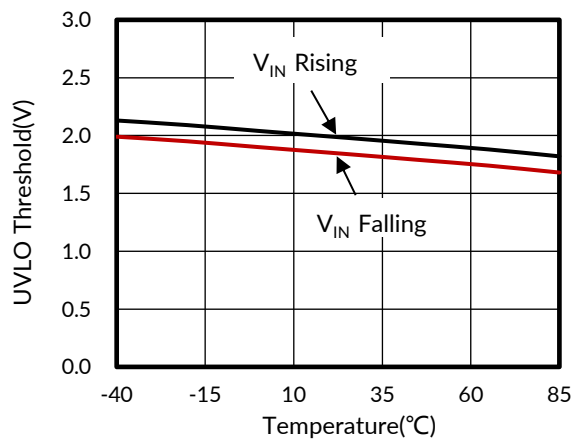

Figure 12. UVLO Threshold vs Temperature

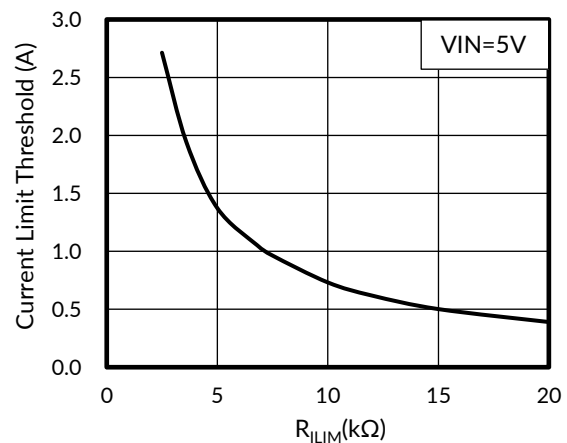

Figure 13. Current Limit Threshold vs R_{ILIM}

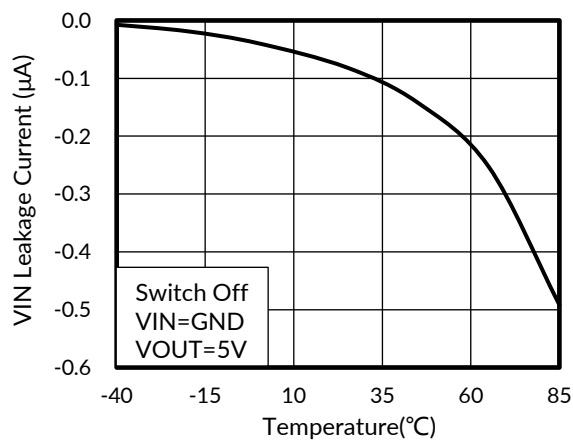

Figure 14. V_{IN} Leakage Current vs Temperature

TYPICAL PERFORMANCE CHARACTERISTICS

NOTE: The graphs and tables provided following this note are a statistical summary based on a limited number of samples and are provided for informational purposes only.

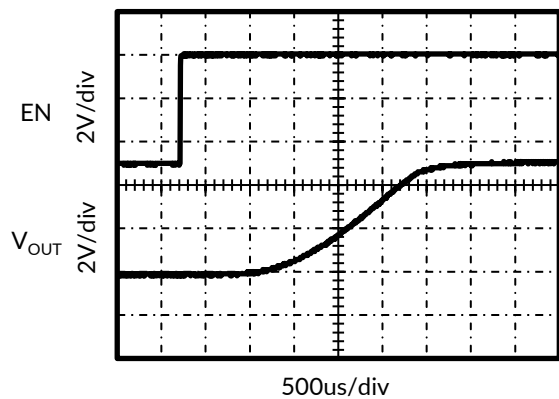

Figure 15. Turn-On Delay Time

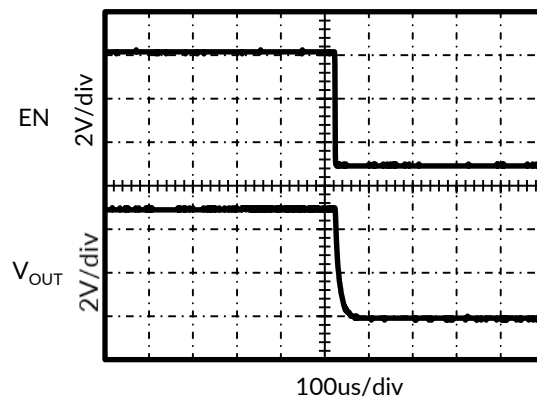

Figure 16. Turn-Off Delay Time

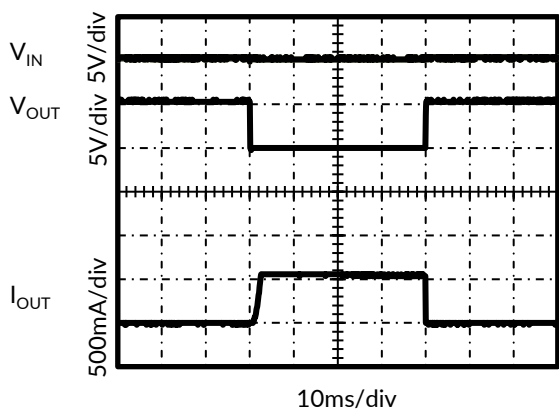

Figure 17. No Load into Short-Circuit

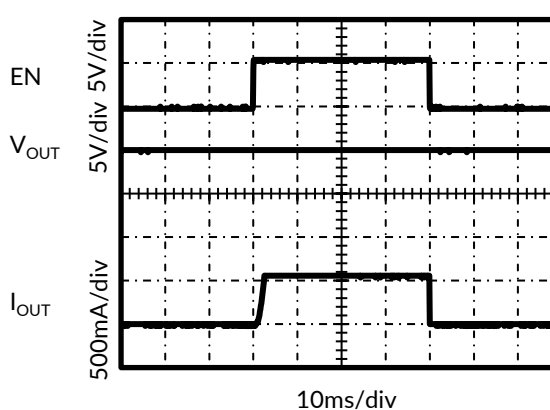

Figure 18. Device Enabled into Short-Circuit

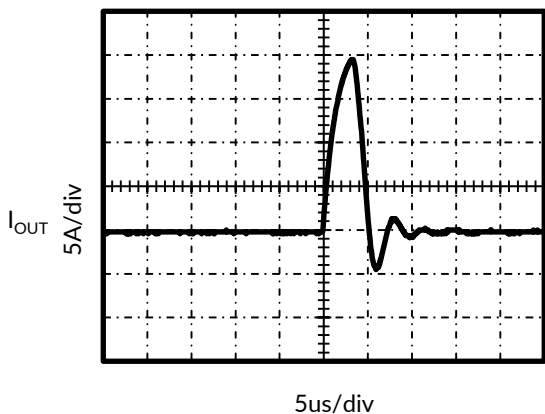

Figure 19. Short-Circuit Response Time

9 DETAILED DESCRIPTION

9.1 Input and Output

VIN is the power supply connection to the logic circuitry and the source of the P-channel MOSFET. OUT is the drain of the P-channel MOSFET. In a typical circuit, current flows from VIN to OUT toward the load. The output P-channel MOSFET and driver circuit are also designed to allow the MOSFET drain to be externally forced to a higher voltage than the source ($V_{OUT} > V_{IN}$) when the switch is disabled.

9.2 Thermal Shutdown

Thermal shutdown is employed to protect device and load from damage because of excessive power dissipation. It shuts off the output MOSFET, if the die temperature exceeds 145°C until the die temperature drops to 125°C.

9.3 Soft-Start

In order to eliminate the upstream voltage sag caused by the large inrush current during hot-plug events, the soft-start feature effectively isolates power supplies from such highly capacitive loads.

9.4 Under-Voltage Lockout (UVLO)

UVLO prevents the MOSFET switch from turning on until input voltage exceeds 1.9V (Typical). If input voltage drops below 1.8V (Typical), UVLO shuts off the MOSFET switch. Under-voltage detection functions only when the switch is enabled.

9.5 Current Limiting and Short-Circuit Protection

The current limit circuit is designed to limit the output current to protect the upstream power supply. Current limit threshold is programmed with a resistor from ILIM to ground marked as R_{ILIM} . It can be estimated by the following equation:

$$I_{LIM} \approx \frac{6800}{R_{ILIM}}, I_{SHORT} \approx 0.75 * \frac{6800}{R_{ILIM}}$$

We recommend the R_{ILIM} value range: 2.5KOhm~18KOhm. For more details, please refer to Figure 13.

Under output short-circuit condition; the typical current limit folded back 75%. If the RS2582 keeps at over-current condition for a long time, the junction temperature may exceed 145°C, and over-temperature protection will shut down the output until temperature drops 125°C or limit (short-circuit) condition is removed.

Table 1. Typical Design Examples

$R_{ILIM}(k\Omega)$	$I_{LIM}(A)$
2.5	2.74
3.3	2.09
4.7	1.46
6.8	1
18	0.38

9.6 Reverse-Voltage Protection

The reverse-voltage protection feature turns off the P-MOSFET switch whenever the output voltage exceeds the input voltage by 50mV.

9.7 Power Dissipation

The device's junction temperature depends on several factors such as the load, PCB layout, ambient temperature, and package type. Equations that can be used to calculate power dissipation and junction temperature are found below:

$$P_D = R_{DS(ON)} \times I_{OUT}^2$$

To relate this to junction temperature, the following equation can be used:

$$T_J = P_D \times \theta_{JA} + T_A$$

Where:

T_J = junction temperature

T_A = ambient temperature

θ_{JA} = the thermal resistance of the package

9.8 Supply Filter Capacitor

In order to prevent the input voltage drooping during hot-plug events, connect a ceramic capacitor (C_{IN}) from VIN to GND. The C_{IN} is positioned close to VIN and GND of the device. However, higher capacitor values could reduce the voltage sag on the input further. Furthermore, an output short will cause ringing on the input without the input capacitor. It could destroy the internal circuitry when the input transient exceeds 6.0V which is the absolute maximum supply voltage even for a short duration.

If the upstream supply cable is long or the VIN transient exceeds 6.0V during the V_{OUT} short, recommend adding a second filter capacitor at the upstream supply output terminal.

9.9 Output Filter Capacitor

A low-ESR 10uF ceramic capacitor between OUT and GND is strongly recommended to reduce the voltage droop during hot-attachment of downstream peripheral. Higher value output capacitor is better when the output load is heavy. Additionally, bypassing the output with a 0.1uF ceramic capacitor improves the immunity of the device to short-circuit transients.

9.10 PCB Layout Guide

For best performance of the RS2582, the following guidelines must be strictly followed:

1. Please place the input capacitors near the VIN pin as close as possible.
2. Keep VIN and OUT traces as wide and short as possible.
3. Locate RS2582 and output capacitors near the load to reduce parasitic resistance and inductance for excellent load transient performance.
4. Input and output capacitors should be placed closed to the IC and connected to ground plane to reduce noise coupling. Place a ground plane under all circuitry to lower both resistance and inductance and improve DC and transient performance
5. The traces routing the R_{ILIM} resistor to the RS2582 should be as short as possible to reduce parasitic effects on the current limit accuracy.

10 PACKAGE OUTLINE DIMENSIONS

SOT23-5 ⁽²⁾

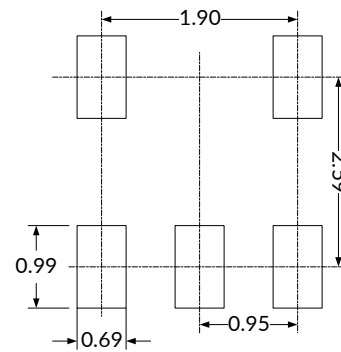
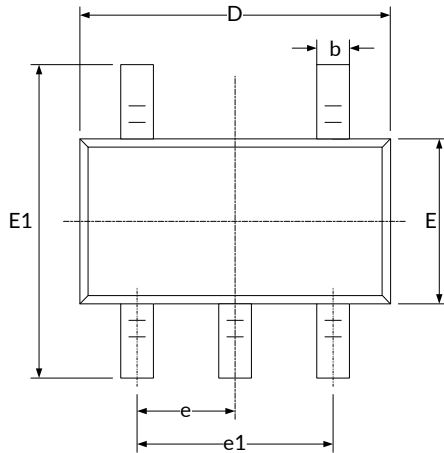

RECOMMENDED LAND PATTERN (Unit: mm)

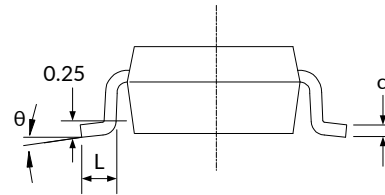
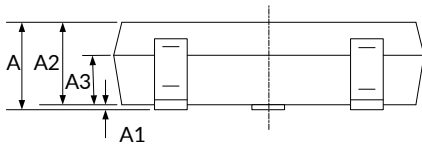

Symbol	Dimensions In Millimeters		Dimensions In Inches	
	Min	Max	Min	Max
A ⁽¹⁾		1.250		0.049
A1	0.020	0.110	0.001	0.004
A2	1.000	1.200	0.039	0.047
A3	0.600	0.700	0.024	0.028
b	0.330	0.410	0.013	0.016
c	0.150	0.190	0.006	0.007
D ⁽¹⁾	2.800	3.000	0.110	0.118
E ⁽¹⁾	1.500	1.700	0.059	0.067
E1	2.600	3.000	0.102	0.118
e	0.850	1.050	0.033	0.041
e1	1.800	2.000	0.071	0.079
L	0.350	0.550	0.014	0.022
θ	0°	8°	0°	8°

NOTE:

1. Plastic or metal protrusions of 0.15mm maximum per side are not included.
2. This drawing is subject to change without notice.

11 TAPE AND REEL INFORMATION

REEL DIMENSIONS

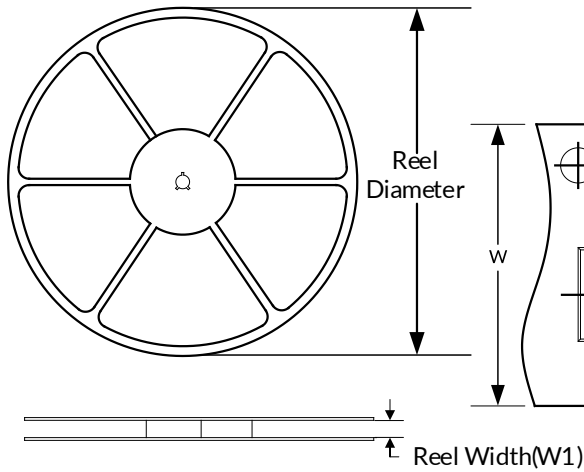

TAPE DIMENSION

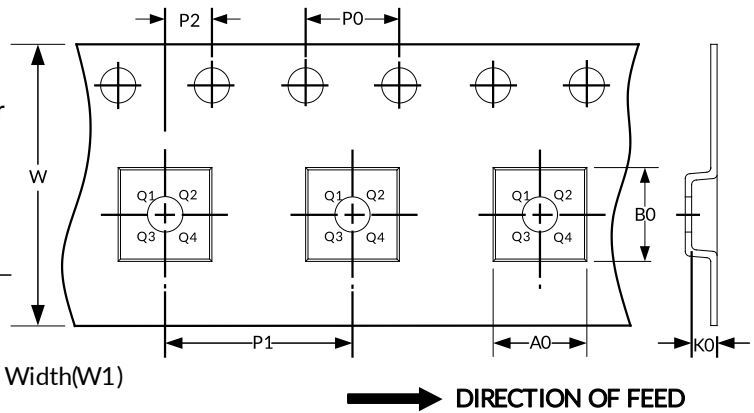

NOTE: The picture is only for reference. Please make the object as the standard.

KEY PARAMETER LIST OF TAPE AND REEL

Package Type	Reel Diameter	Reel Width (mm)	A0 (mm)	B0 (mm)	K0 (mm)	P0 (mm)	P1 (mm)	P2 (mm)	W (mm)	Pin1 Quadrant
SOT23-5	7"	9.5	3.20	3.20	1.40	4.0	4.0	2.0	8.0	Q3

NOTE:

1. All dimensions are nominal.
2. Plastic or metal protrusions of 0.15mm maximum per side are not included.

IMPORTANT NOTICE AND DISCLAIMER

Jiangsu Runic Technology Co., Ltd. will accurately and reliably provide technical and reliability data (including data sheets), design resources (including reference designs), application or other design advice, WEB tools, safety information and other resources, without warranty of any defect, and will not make any express or implied warranty, including but not limited to the warranty of merchantability Implied warranty that it is suitable for a specific purpose or does not infringe the intellectual property rights of any third party.

These resources are intended for skilled developers designing with Runic products You will be solely responsible for: (1) Selecting the appropriate products for your application; (2) Designing, validating and testing your application; (3) Ensuring your application meets applicable standards and any other safety, security or other requirements; (4) Runic and the Runic logo are registered trademarks of Runic Incorporated. All trademarks are the property of their respective owners; (5) For change details, review the revision history included in any revised document. The resources are subject to change without notice. Our company will not be liable for the use of this product and the infringement of patents or third-party intellectual property rights due to its use.