

RS4GT126 Quadruple Bus Buffer Gate With 3-State Outputs

1 FEATURES

- **Operating Voltage Range: 2V to 5.5V**
- **Low Power Consumption: 1 μ A (Max)**
- **Operating Temperature Range: -40°C to +125°C**
- **Inputs Are TTL-Voltage Compatible**
- **\pm 32mA Output Drive at V_{CC}=5.0V**
- **Latch-up Performance Exceeds 100mA**
- **Micro SIZE PACKAGES: SOP14 and TSSOP14**

2 APPLICATIONS

- **AV Receiver**
- **Cable Modem Termination Systems**
- **Digital Picture Frame (DPF)**
- **High-Speed Data Acquisition and Generation**
- **Motor Controls: High-Voltage**
- **Personal Navigation Device (GPS)**
- **Portable Media Player**
- **Video Communication Systems**

Simplified Schematic

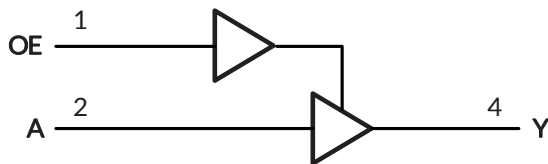

3 DESCRIPTIONS

The quadruple buffer is designed for 2V to 5.5V V_{CC} operation. The RS4GT126 device is quadruple line driver with 3-state output. The output is disabled when the output-enable input is low.

This device is fully specified for partial-power-down applications using I_{off}. The I_{off} circuitry disables the outputs, preventing damaging current backflow through the device when it is powered down.

To ensure the high-impedance state during power up or power down, OE should be tied to GND through a pull-down resistor, the minimum value of the resistor is determined by the current-sourcing capability of the driver.

The RS4GT126 is available in Green SOP14 and TSSOP14 packages. It operates over an ambient temperature range of -40°C to +125°C.

Device Information (1)

PART NUMBER	PACKAGE	BODY SIZE (NOM)
RS4GT126	SOP14	8.65mm×3.90mm
	TSSOP14	5.00mm×4.40mm

(1) For all available packages, see the orderable addendum at the end of the data sheet.

FUNCTION TABLE

INPUTS		OUTPUT
OE	A	Y
H	H	H
H	L	L
L	X	Z

H=HIGH Logic Level

L =LOW Logic Level

X=Don't Care

Z=High-impedance OFF-state

Table of Contents

1 FEATURES	1
2 APPLICATIONS	1
3 DESCRIPTIONS	1
4 Revision History	3
5 PACKAGE/ORDERING INFORMATION ⁽¹⁾	4
6 PIN CONFIGURATIONS	5
7 Specifications	6
7.1 Absolute Maximum Ratings ⁽¹⁾	6
7.2 ESD Ratings	6
8 ELECTRICAL CHARACTERISTICS	7
8.1 Recommended Operating Conditions	7
8.2 DC Characteristics	7
8.3 AC Characteristics	8
9 Parameter Measurement Information	9
10 PACKAGE OUTLINE DIMENSIONS	10
11 TAPE AND REEL INFORMATION	12

4 Revision History

Note: Page numbers for previous revisions may differ from page numbers in the current version.

Version	Change Date	Change Item
A.1	2023/11/08	Initial version completed
A.1.1	2024/02/29	Modify packaging naming

5 PACKAGE/ORDERING INFORMATION (1)

PRODUCT	ORDERING NUMBER	TEMPERATURE RANGE	PACKAGE LEAD	PACKAGE MARKING (2)	MSL (3)	PACKAGE OPTION
RS4GT126	RS4GT126XP	-40°C ~+125°C	SOP14	RS4GT126	MSL3	Tape and Reel,4000
	RS4GT126XQ	-40°C ~+125°C	TSSOP14	RS4GT126	MSL3	Tape and Reel,4000

NOTE:

- (1) This information is the most current data available for the designated devices. This data is subject to change without notice and revision of this document. For browser-based versions of this data sheet, refer to the right-hand navigation.
- (2) There may be additional marking, which relates to the lot trace code information (data code and vendor code), the logo or the environmental category on the device.
- (3) MSL, The Moisture Sensitivity Level rating according to the JEDEC industry standard classifications.

Marking Information

(1) SOP14

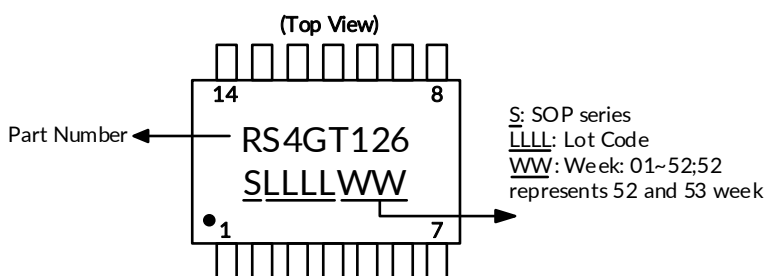

(2) TSSOP14

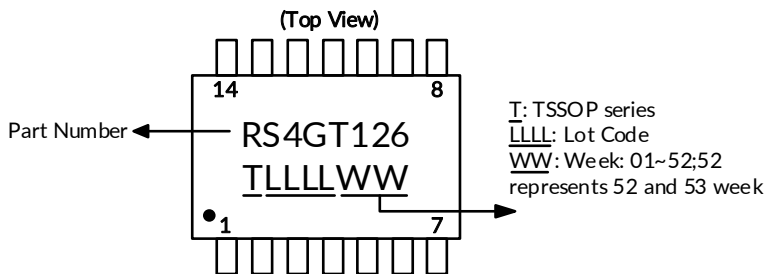

6 PIN CONFIGURATIONS

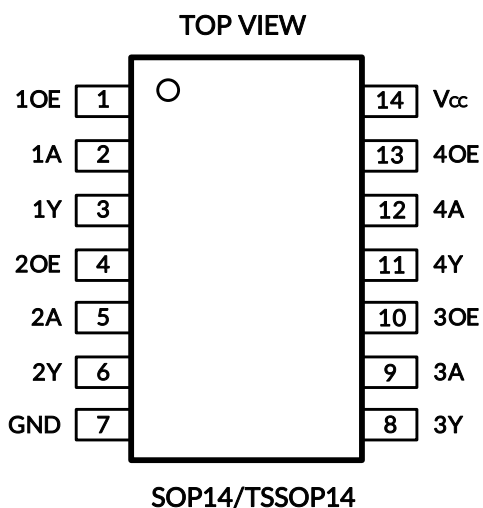

PIN DESCRIPTION

PIN	NAME	I/O TYPE ⁽¹⁾	FUNCTION
SOP14/TSSOP14			
1	1OE	I	Output Enable for buffer 1
2	1A	I	Input of buffer 1
3	1Y	O	Output of buffer 1
4	2OE	I	Output Enable for buffer 2
5	2A	I	Input of buffer 2
6	2Y	O	Output of buffer 2
7	GND	-	Ground
8	3Y	O	Output of buffer 3
9	3A	I	Input of buffer 3
10	3OE	I	Output Enable for buffer 3
11	4Y	O	Output of buffer 4
12	4A	I	Input of buffer 4
13	4OE	I	Output Enable for buffer 4
14	V _{CC}	-	Power Supply

(1) I=input, O=output.

7 Specifications

7.1 Absolute Maximum Ratings ⁽¹⁾

over operating free-air temperature range (unless otherwise noted) ^{(1) (2)}

		MIN	MAX	UNIT
V _{CC}	Supply voltage range	-0.5	6.5	V
V _I	Input voltage range ⁽²⁾	-0.5	6.5	V
V _O	Voltage range applied to any output in the high-impedance or power-off state ⁽²⁾	-0.5	6.5	V
V _O	Voltage range applied to any output in the high or low state ⁽²⁾⁽³⁾	-0.5	V _{CC} +0.5	V
I _{IK}	Input clamp current	V _I <0	-50	mA
I _{OK}	Output clamp current	V _O <0	-50	mA
I _O	Continuous output current		±50	mA
	Continuous current through V _{CC} or GND		±100	mA
θ _{JA}	Package thermal impedance ⁽⁴⁾	SOP14	105	°C/W
		TSSOP14	90	
T _J	Junction temperature ⁽⁵⁾	-65	150	°C
T _{stg}	Storage temperature	-65	150	°C

- (1) Stresses beyond those listed under Absolute Maximum Ratings may cause permanent damage to the device. These are stress ratings only, and functional operation of the device at these or any other conditions beyond those indicated under Recommended Operating Conditions is not implied. Exposure to absolute-maximum-rated conditions for extended periods may affect device reliability.
- (2) The input and output negative-voltage ratings may be exceeded if the input and output current ratings are observed.
- (3) The value of V_{CC} is provided in the Recommended Operating Conditions table.
- (4) The package thermal impedance is calculated in accordance with JESD-51.
- (5) The maximum power dissipation is a function of T_{J(MAX)}, R_{θJA}, and T_A. The maximum allowable power dissipation at any ambient temperature is P_D = (T_{J(MAX)} - T_A) / R_{θJA}. All numbers apply for packages soldered directly onto a PCB.

7.2 ESD Ratings

The following ESD information is provided for handling of ESD-sensitive devices in an ESD protected area only.

		VALUE	UNIT
V _(ESD)	Electrostatic discharge	Human-body model (HBM), MIL-STD-883K METHOD 3015.9	±2000
		Charged-device model (CDM), ANSI/ESDA/JEDEC JS-002-2018	±1000
		Machine Model (MM), JESD22-A115C (2010)	±200



ESD SENSITIVITY CAUTION

ESD damage can range from subtle performance degradation to complete device failure. Precision integrated circuits may be more susceptible to damage because very small parametric changes could cause the device not to meet its published specifications.

8 ELECTRICAL CHARACTERISTICS

over recommended operating free-air temperature range (TYP values are at $T_A = +25^{\circ}\text{C}$, unless otherwise noted.)⁽¹⁾

8.1 Recommended Operating Conditions

PARAMETER	SYMBOL	TEST CONDITIONS	MIN	MAX	UNIT
Supply voltage	V_{CC}	Operating	2	5.5	V
High-level input voltage	V_{IH}	$V_{CC}=2\text{V}$	1		V
		$V_{CC}=3.3\text{V}$	1.5		
		$V_{CC}=4.5\text{V to }5.5\text{V}$	2		
Low-level input voltage	V_{IL}	$V_{CC}=2\text{V}$		0.3	V
		$V_{CC}=3.3\text{V}$		0.55	
		$V_{CC}=4.5\text{V to }5.5\text{V}$		0.8	
Input voltage	V_I		0	5.5	V
Output voltage	V_O		0	V_{CC}	V
Input transition rise or fall	t_r, t_f	$V_{CC}=2.0\text{V to }5.5\text{V}$		5	ns/V
Operating temperature	T_A		-40	125	$^{\circ}\text{C}$

(1) All unused inputs of the device must be held at V_{CC} or GND to ensure proper device operation.

8.2 DC Characteristics

PARAMETER	TEST CONDITIONS	V_{CC}	TEMP	MIN ⁽²⁾	TYP ⁽³⁾	MAX ⁽²⁾	UNIT
V_{OH}	$I_{OH} = -100\mu\text{A}$	2V to 5.5V	Full	$V_{CC}-0.1$			V
	$I_{OH} = -8\text{mA}$	2V		1.2			
	$I_{OH} = -24\text{mA}$	3.3V		1.9			
	$I_{OH} = -32\text{mA}$	4.5V		2.4			
		5V		2.3			
		5.5V		3.8			
V_{OL}	$I_{OL} = 100\mu\text{A}$	2V to 5.5V	Full			0.1	V
	$I_{OL} = 8\text{mA}$	2V				0.45	
	$I_{OL} = 24\text{mA}$	3.3V				0.3	
	$I_{OL} = 32\text{mA}$	4.5V				0.4	
		5V				0.55	
		5.5V				0.55	
I_i	A or OE inputs	$V_I=5.5\text{V or GND}$	0V to 5.5V	+25 $^{\circ}\text{C}$	± 0.1	± 1	μA
				Full		± 5	
I_{off}	$V_I \text{ or } V_O=5.5\text{V}$	0V		+25 $^{\circ}\text{C}$	± 0.1	± 1	μA
				Full		± 10	
I_{CC}	$V_I=5.5\text{V or GND, } I_O=0$	2V to 5.5V		+25 $^{\circ}\text{C}$	0.1	1	μA
				Full		10	
I_{CCT}	One input at $V_{CC}=3.4\text{V}$, Other inputs at V_{CC} or GND	5.5V	Full			500	μA
C_i (Input Capacitance)	$V_{CC}=0\text{V, } f = 10\text{MHz}$	0V	+25 $^{\circ}\text{C}$		4		pF

(1) All unused inputs of the device must be held at V_{CC} or GND to ensure proper device operation.

(2) This parameter is ensured by design and/or characterization and is not tested in production.

(3) Typical values represent the most likely parametric norm as determined at the time of characterization. Actual typical values may vary over time and will also depend on the application and configuration.

8.3 AC Characteristics

PARAMETER		SYMBOL	TEST CONDITIONS		MIN ⁽²⁾	TYP ⁽³⁾	MAX ⁽²⁾	UNIT
Propagation Delay		t_{pd}	$V_{CC}=2.0V\pm 0.2V$	$C_L=30pF, R_L=500\Omega$		15.5		ns
			$V_{CC}=3.3V\pm 0.3V$	$C_L=50pF, R_L=500\Omega$		9.7		
			$V_{CC}=5.0V\pm 0.5V$	$C_L=50pF, R_L=500\Omega$		7.5		
Enable Time		t_{en}	$V_{CC}=2.0V\pm 0.2V$	$C_L=30pF, R_L=500\Omega$		10.8		ns
			$V_{CC}=3.3V\pm 0.3V$	$C_L=50pF, R_L=500\Omega$		7.4		
			$V_{CC}=5.0V\pm 0.5V$	$C_L=50pF, R_L=500\Omega$		6.04		
Disable Time		t_{dis}	$V_{CC}=2.0V\pm 0.2V$	$C_L=30pF, R_L=500\Omega$		13.6		ns
			$V_{CC}=3.3V\pm 0.3V$	$C_L=50pF, R_L=500\Omega$		9.7		
			$V_{CC}=5.0V\pm 0.5V$	$C_L=50pF, R_L=500\Omega$		7.7		
Power dissipation capacitance	Output enabled	C_{pd}	$V_{CC}=5V$	$f=10MHz$		40		pF
	Output disabled					4		

(1) All unused inputs of the device must be held at V_{CC} or GND to ensure proper device operation.

(2) This parameter is ensured by design and/or characterization and is not tested in production.

(3) Typical values represent the most likely parametric norm as determined at the time of characterization. Actual typical values may vary over time and will also depend on the application and configuration.

9 Parameter Measurement Information

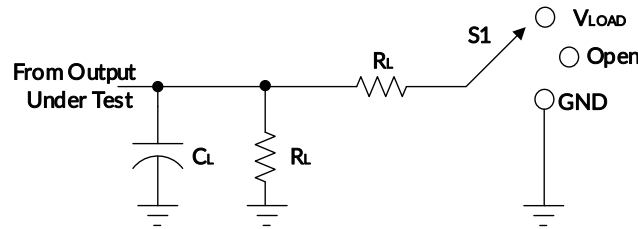

TEST	S1
t_{PLH}/t_{PHL}	Open
t_{PLZ}/t_{PZL}	V_{LOAD}
t_{PHZ}/t_{PZH}	GND

V_{CC}	INPUTS		V_M	V_{LOAD}	C_L	R_L	V_{Δ}
	V_i	t_r/t_f					
$2.0V \pm 0.2V$	V_{CC}	$\leq 2ns$	$V_{CC}/2$	$2 \times V_{CC}$	30pF	500 Ω	0.15V
$3.3V \pm 0.3V$	3V	$\leq 2.5ns$	1.5V	6V	50pF	500 Ω	0.3V
$5V \pm 0.5V$	V_{CC}	$\leq 2.5ns$	$V_{CC}/2$	$2 \times V_{CC}$	50pF	500 Ω	0.3V

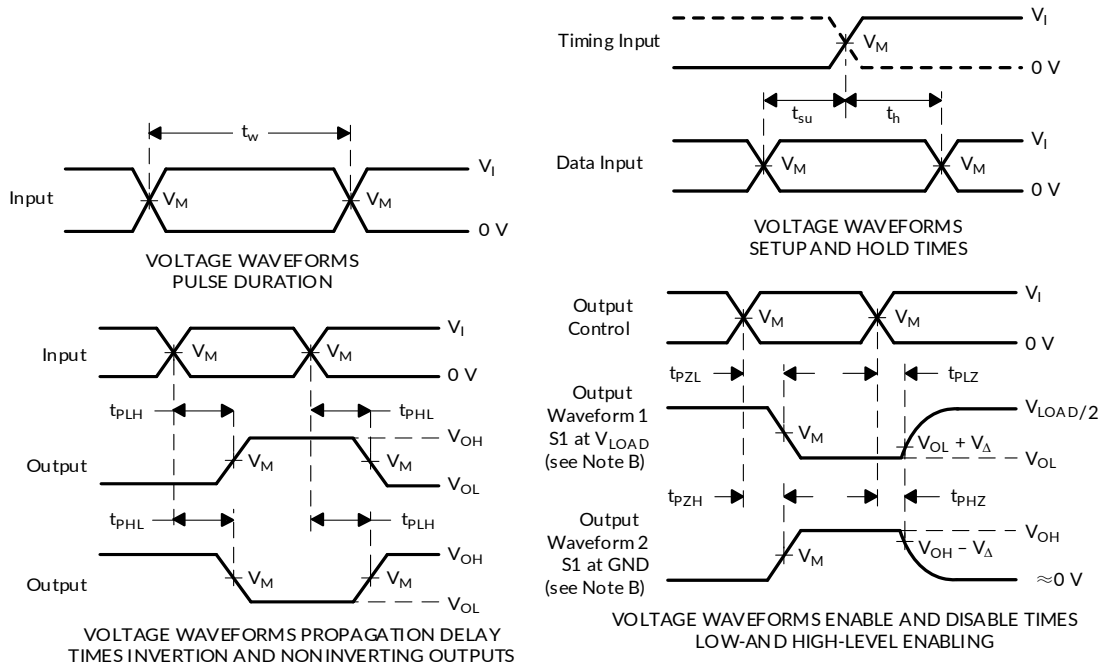

- NOTES:
- A. C_L includes probe and jig capacitance.
 - B. Waveform 1 is for an output with internal conditions such that the output is low, except when disabled by the output control. Waveform 2 is for an output with internal conditions such that the output is high, except when disabled by the output control.
 - C. All input pulses are supplied by generators having the following characteristics: $PRR \leq 10 \text{ MHz}$, $Z_0 = 50 \Omega$.
 - D. The outputs are measured one at a time, with one transition per measurement.
 - E. t_{PLZ} and t_{PHZ} are the same as t_{dis} .
 - F. t_{PZL} and t_{PZH} are the same as t_{en} .
 - G. t_{PLH} and t_{PHL} are the same as t_{pd} .
 - H. All parameters and waveforms are not applicable to all devices.

Figure 1. Load Circuit and Voltage Waveforms

10 PACKAGE OUTLINE DIMENSIONS

SOP14⁽³⁾

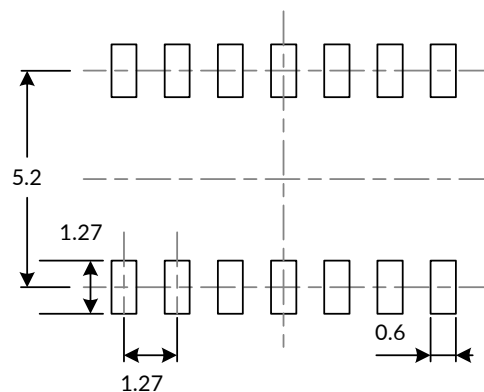
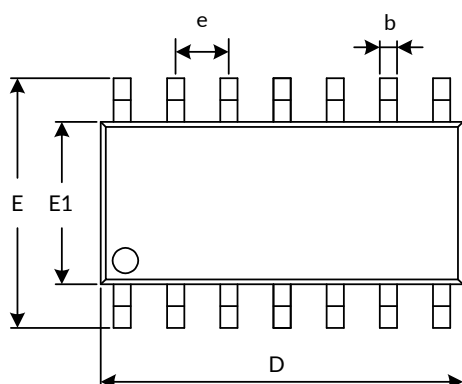

RECOMMENDED LAND PATTERN (Unit: mm)

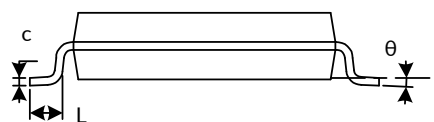
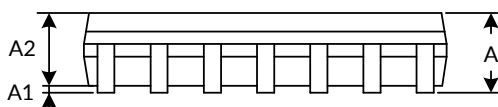

Symbol	Dimensions In Millimeters		Dimensions In Inches	
	Min	Max	Min	Max
A ⁽¹⁾		1.750		0.069
A1	0.100	0.250	0.004	0.010
A2	1.300	1.500	0.051	0.059
b	0.390	0.470	0.015	0.019
c	0.200	0.240	0.008	0.009
D ⁽¹⁾	8.550	8.750	0.336	0.344
e	1.270(BSC) ⁽²⁾		0.050(BSC) ⁽²⁾	
E	5.800	6.200	0.228	0.244
E1 ⁽¹⁾	3.800	4.000	0.150	0.157
L	0.500	0.800	0.020	0.031
θ	0°	8°	0°	8°

NOTE:

1. Plastic or metal protrusions of 0.15mm maximum per side are not included.
2. BSC (Basic Spacing between Centers), "Basic" spacing is nominal.
3. This drawing is subject to change without notice.

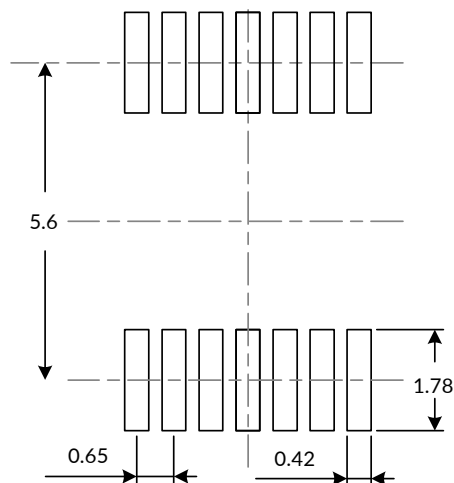
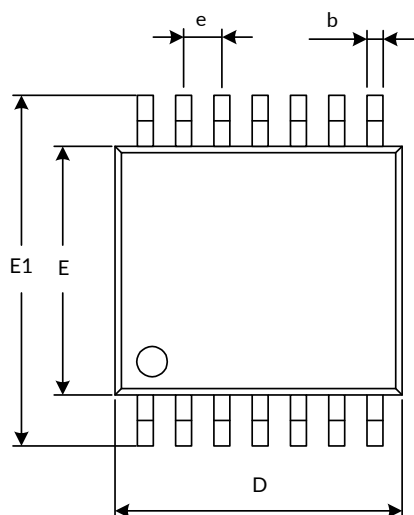
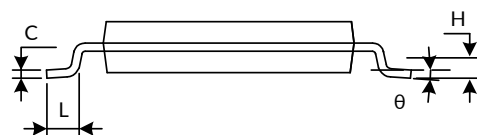
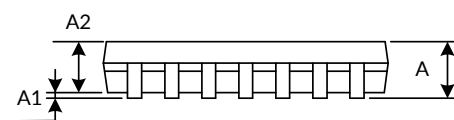
TSSOP14 (3)

RECOMMENDED LAND PATTERN (Unit: mm)

Symbol	Dimensions In Millimeters		Dimensions In Inches	
	Min	Max	Min	Max
A ⁽¹⁾		1.200		0.047
A1	0.050	0.150	0.002	0.006
A2	0.900	1.050	0.035	0.041
b	0.200	0.300	0.008	0.012
c	0.130	0.170	0.005	0.007
D ⁽¹⁾	4.860	5.100	0.191	0.201
E ⁽¹⁾	4.300	4.500	0.169	0.177
E1	6.200	6.600	0.244	0.260
e	0.650(BSC) ⁽²⁾		0.026(BSC) ⁽²⁾	
L	0.450	0.750	0.018	0.030
H	0.250(TYP)		0.010(TYP)	
θ	0°	8°	0°	8°

NOTE:

1. Plastic or metal protrusions of 0.15mm maximum per side are not included.
2. BSC (Basic Spacing between Centers), "Basic" spacing is nominal.
3. This drawing is subject to change without notice.

11 TAPE AND REEL INFORMATION

REEL DIMENSIONS

TAPE DIMENSION

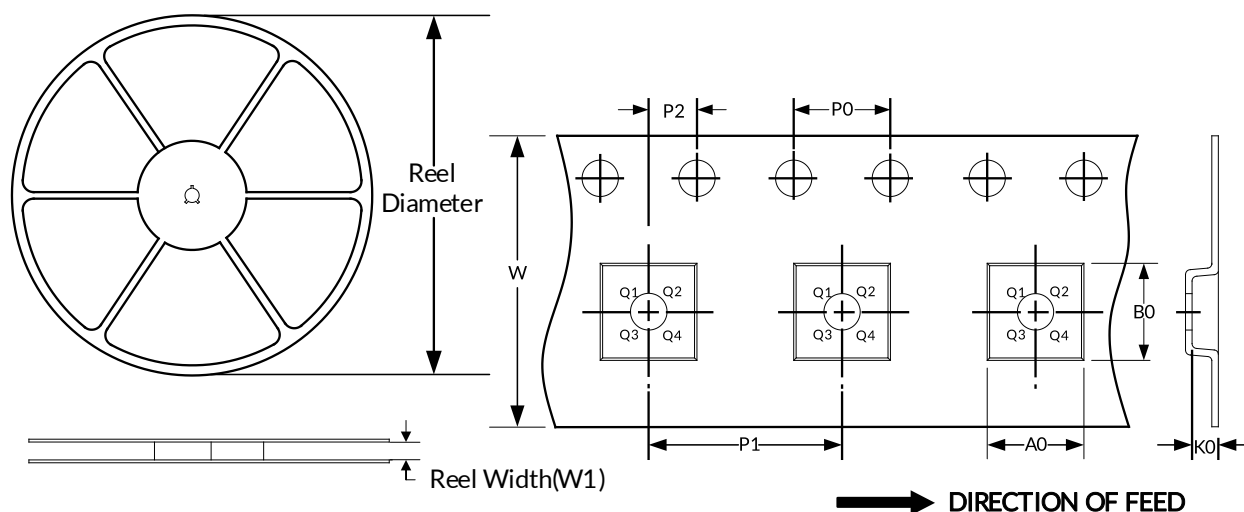

NOTE: The picture is only for reference. Please make the object as the standard.

KEY PARAMETER LIST OF TAPE AND REEL

Package Type	Reel Diameter	Reel Width(mm)	A0 (mm)	B0 (mm)	K0 (mm)	P0 (mm)	P1 (mm)	P2 (mm)	W (mm)	Pin1 Quadrant
SOP14	13"	16.4	6.60	9.30	2.10	4.0	8.0	2.0	16.0	Q1
TSSOP14	13"	12.4	6.95	5.60	1.20	4.0	8.0	2.0	12.0	Q1

NOTE:

1. All dimensions are nominal.
2. Plastic or metal protrusions of 0.15mm maximum per side are not included.

IMPORTANT NOTICE AND DISCLAIMER

Jiangsu Runic Technology Co., Ltd. will accurately and reliably provide technical and reliability data (including data sheets), design resources (including reference designs), application or other design advice, WEB tools, safety information and other resources, without warranty of any defect, and will not make any express or implied warranty, including but not limited to the warranty of merchantability Implied warranty that it is suitable for a specific purpose or does not infringe the intellectual property rights of any third party.

These resources are intended for skilled developers designing with Runic products You will be solely responsible for: (1) Selecting the appropriate products for your application; (2) Designing, validating and testing your application; (3) Ensuring your application meets applicable standards and any other safety, security or other requirements; (4) Runic and the Runic logo are registered trademarks of Runic Incorporated. All trademarks are the property of their respective owners; (5) For change details, review the revision history included in any revised document. The resources are subject to change without notice. Our company will not be liable for the use of this product and the infringement of patents or third-party intellectual property rights due to its use.