

# RS1GT00 Single 2-Input Positive-NAND Gate

## 1 FEATURES

- **Operating Voltage Range: 2.0V to 5.5V**
- **Low Power Consumption: 1μA (Max)**
- **Operating Temperature Range: -40°C to +125°C**
- **Inputs Are TTL-Voltage Compatible**
- **High Output Drive: ±32mA at V<sub>CC</sub>=5.0V**
- **Micro SIZE PACKAGES: SOT23-5, SC70-5**

## 2 APPLICATIONS

- **Active Noise Elimination**
- **Bar Code Scanner**
- **Blood Pressure Monitor**
- **CPAP Machine**
- **Fingerprint identification**
- **Network attached storage (NAS)**

## 3 DESCRIPTIONS

The RS1GT00 single 2-input positive-NAND gate is designed for 2.0V to 5.5V V<sub>CC</sub> operation.

The RS1GT00 device performs the Boolean function  $Y = \overline{A \cdot B}$  or  $Y = \overline{A} + \overline{B}$  in positive logic. The device is fully specified for partial-power-down applications using I<sub>off</sub>. The I<sub>off</sub> circuitry disables the outputs, preventing damaging current backflow through the device when it is powered down.

The RS1GT00 is available in Green SOT23-5 and SC70-5 packages. It operates over an ambient temperature range of -40°C to +125°C.

### Device Information (1)

PART NUMBER	PACKAGE	BODY SIZE (NOM)
RS1GT00	SOT23-5	2.92mm×1.60mm
	SC70-5	2.10mm×1.25mm

(1) For all available packages, see the orderable addendum at the end of the data sheet.

### LOGIC SYMBOL

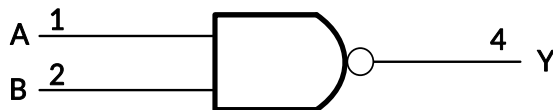

## 4 FUNCTION TABLE

INPUTS		OUTPUT
A	B	Y
H	H	L
L	H	H
H	L	H
L	L	H

H=High Voltage Level  
L=Low Voltage Level

## Table of Contents

<b>1 FEATURES</b> .....	1
<b>2 APPLICATIONS</b> .....	1
<b>3 DESCRIPTIONS</b> .....	1
<b>4 FUNCTION TABLE</b> .....	1
<b>5 Revision History</b> .....	3
<b>6 PACKAGE/ORDERING INFORMATION</b> <sup>(1)</sup> .....	4
<b>7 PIN CONFIGURATIONS</b> .....	5
<b>8 SPECIFICATIONS</b> .....	6
8.1 Absolute Maximum Ratings .....	6
8.2 ESD Ratings .....	6
<b>9 ELECTRICAL CHARACTERISTICS</b> .....	7
9.1 Recommended Operating Conditions.....	7
9.2 DC Characteristics .....	7
9.3 AC Characteristics.....	8
<b>10 Parameter Measurement Information</b> .....	9
<b>11 PACKAGE OUTLINE DIMENSIONS</b> .....	10
<b>12 TAPE AND REEL INFORMATION</b> .....	12

## 5 Revision History

Note: Page numbers for previous revisions may differ from page numbers in the current version.

Version	Change Date	Change Item
A.1	2024/03/06	Initial version completed

**6 PACKAGE/ORDERING INFORMATION <sup>(1)</sup>**

PRODUCT	ORDERING NUMBER	TEMPERATURE RANGE	PACKAGE LEAD	PACKAGE MARKING <sup>(2)</sup>	MSL <sup>(3)</sup>	PACKAGE OPTION
RS1GT00	RS1GT00XF5	-40°C ~+125°C	SOT23-5	1GT00	MSL3	Tape and Reel,3000
	RS1GT00XC5	-40°C ~+125°C	SC70-5 <sup>(4)</sup>	1GT00	MSL3	Tape and Reel,3000

**NOTE:**

- (1) This information is the most current data available for the designated devices. This data is subject to change without notice and revision of this document. For browser-based versions of this data sheet, refer to the right-hand navigation.
- (2) There may be additional marking, which relates to the lot trace code information (data code and vendor code), the logo or the environmental category on the device.
- (3) MSL, The Moisture Sensitivity Level rating according to the JEDEC industry standard classifications.
- (4) Equivalent to SOT353.

## 7 PIN CONFIGURATIONS

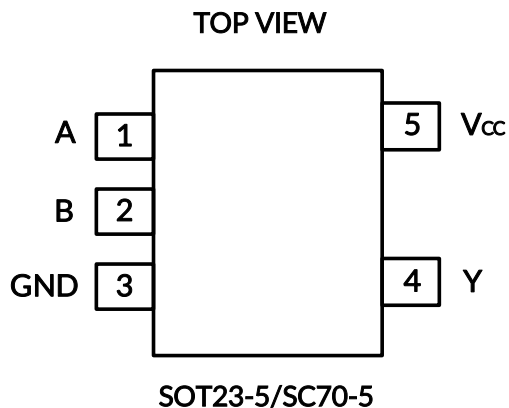

### PIN DESCRIPTION

PIN	NAME	I/O <sup>(1)</sup>	FUNCTION
<b>SOT23-5/SC70-5</b>			
1	A	I	Input
2	B	I	Input
3	GND	P	Ground
4	Y	O	Output
5	V <sub>CC</sub>	P	Power pin

(1) I=input, O=output, P=power.

## 8 SPECIFICATIONS

### 8.1 Absolute Maximum Ratings

over operating free-air temperature range (unless otherwise noted) <sup>(1) (2)</sup>

		MIN	MAX	UNIT
V <sub>CC</sub>	Supply voltage range	-0.5	6.5	V
V <sub>I</sub>	Input voltage range <sup>(2)</sup>	-0.5	6.5	V
V <sub>O</sub>	Voltage range applied to any output in the high-impedance or power-off state <sup>(2)</sup>	-0.5	6.5	V
V <sub>O</sub>	Voltage range applied to any output in the high or low state <sup>(2) (3)</sup>	-0.5	V <sub>CC</sub> +0.5	V
I <sub>IK</sub>	Input clamp current	V <sub>I</sub> <0	-50	mA
I <sub>OK</sub>	Output clamp current	V <sub>O</sub> <0	-50	mA
I <sub>O</sub>	Continuous output current		±50	mA
	Continuous current through V <sub>CC</sub> or GND		±100	mA
θ <sub>JA</sub>	Package thermal impedance <sup>(4)</sup>	SOT23-5	208	°C/W
		SC70-5	283	
T <sub>J</sub>	Junction temperature <sup>(5)</sup>	-65	150	°C
T <sub>stg</sub>	Storage temperature	-65	150	°C

- (1) Stresses beyond those listed under Absolute Maximum Ratings may cause permanent damage to the device. These are stress ratings only, and functional operation of the device at these or any other conditions beyond those indicated under Recommended Operating Conditions is not implied. Exposure to absolute-maximum-rated conditions for extended periods may affect device reliability.
- (2) The input and output negative-voltage ratings may be exceeded if the input and output current ratings are observed.
- (3) The value of V<sub>CC</sub> is provided in the Recommended Operating Conditions table.
- (4) The package thermal impedance is calculated in accordance with JESD-51.
- (5) The maximum power dissipation is a function of T<sub>J(MAX)</sub>, R<sub>θJA</sub>, and T<sub>A</sub>. The maximum allowable power dissipation at any ambient temperature is P<sub>D</sub> = (T<sub>J(MAX)</sub> - T<sub>A</sub>) / R<sub>θJA</sub>. All numbers apply for packages soldered directly onto a PCB.

### 8.2 ESD Ratings

The following ESD information is provided for handling of ESD-sensitive devices in an ESD protected area only.

		VALUE	UNIT
V <sub>(ESD)</sub>	Electrostatic discharge		
	Human-body model (HBM), MIL-STD-883K METHOD 3015.9	±2000	V
	Charged-device model (CDM), ANSI/ESDA/JEDEC JS-002-2018	±1000	V
	Machine Model (MM), JESD22-A115C (2010)	±200	V



#### ESD SENSITIVITY CAUTION

ESD damage can range from subtle performance degradation to complete device failure. Precision integrated circuits may be more susceptible to damage because very small parametric changes could cause the device not to meet its published specifications.

## 9 ELECTRICAL CHARACTERISTICS

over recommended operating free-air temperature range (TYP values are at  $T_A = +25^\circ\text{C}$ , Full= $-40^\circ\text{C}$  to  $125^\circ\text{C}$ , unless otherwise noted.)<sup>(1)</sup>

### 9.1 Recommended Operating Conditions

PARAMETER	SYMBOL	TEST CONDITIONS	MIN	MAX	UNIT
Supply voltage	$V_{CC}$	Operating	2.0	5.5	V
High-level input voltage	$V_{IH}$	$V_{CC}=2.0\text{V}$	1.0		V
		$V_{CC}=3.3\text{V}$	1.5		
		$V_{CC}=4.5\text{V to }5.5\text{V}$	2.0		
Low-level input voltage	$V_{IL}$	$V_{CC}=2.0\text{V}$		0.3	V
		$V_{CC}=3.3\text{V}$		0.55	
		$V_{CC}=4.5\text{V to }5.5\text{V}$		0.8	
Input voltage	$V_I$		0	5.5	V
Output voltage	$V_O$		0	$V_{CC}$	V
Input transition rise or fall	$\Delta t/\Delta v$	$V_{CC}=2.0\text{V to }5.5\text{V}$		5	ns/V
Operating temperature	$T_A$		-40	125	$^\circ\text{C}$

(1) All unused inputs of the device must be held at  $V_{CC}$  or GND to ensure proper device operation.

### 9.2 DC Characteristics

PARAMETER	TEST CONDITIONS	$V_{CC}$	TEMP	MIN <sup>(2)</sup>	TYP <sup>(3)</sup>	MAX <sup>(2)</sup>	UNIT
$V_{OH}$	$I_{OH} = -100\mu\text{A}$	2.0V to 5.5V	Full	$V_{CC}-0.1$			V
	$I_{OH} = -8\text{mA}$	2.0V		1.6			
	$I_{OH} = -24\text{mA}$	3.3V		2.5			
	$I_{OH} = -32\text{mA}$	4.5V		3.8			
		5V		4.2			
		5.5V		4.8			
$V_{OL}$	$I_{OL} = 100\mu\text{A}$	2.0V to 5.5V	Full			0.1	V
	$I_{OL} = 8\text{mA}$	2.0V				0.45	
	$I_{OL} = 24\text{mA}$	3.3V				0.55	
	$I_{OL} = 32\text{mA}$	4.5V				0.55	
		5V				0.5	
		5.5V				0.45	
$I_i$	A or B inputs	$V_I=5.5\text{V or GND}$	0V to 5.5V	+25 $^\circ\text{C}$	$\pm 0.1$	$\pm 1$	$\mu\text{A}$
				Full		$\pm 5$	
$I_{off}$		$V_I \text{ or } V_O=5.5\text{V}$	0V	+25 $^\circ\text{C}$	$\pm 0.1$	$\pm 1$	$\mu\text{A}$
				Full		$\pm 10$	
$I_{CC}$		$V_I=5.5\text{V or GND, } I_O=0$	2.0V to 5.5V	+25 $^\circ\text{C}$	0.1	1	$\mu\text{A}$
				Full		10	
ICCT	One input at 3.4V, Other inputs at $V_{CC}$ or GND	5.5V	Full			500	$\mu\text{A}$
$C_i$ (Input Capacitance)	$V_{CC}=0\text{V, } f=10\text{MHz}$	0V	+25 $^\circ\text{C}$		1.5		pF

(1) All unused inputs of the device must be held at  $V_{CC}$  or GND to ensure proper device operation.

(2) Limits are 100% production tested at 25 $^\circ\text{C}$ . Limits over the operating temperature range are ensured through correlations using statistical quality control (SQC) method.

(3) Typical values represent the most likely parametric norm as determined at the time of characterization. Actual typical values may vary over time and will also depend on the application and configuration.

**9.3 AC Characteristics**

PARAMETER	SYMBOL	TEST CONDITIONS		MIN <sup>(2)</sup>	TYP <sup>(3)</sup>	MAX <sup>(2)</sup>	UNIT
Propagation Delay	$t_{pd}$	$V_{CC}=2.0V\pm 0.2V$	$C_L=30pF, R_L=500\Omega$		8.8		ns
		$V_{CC}=3.3V\pm 0.3V$	$C_L=50pF, R_L=500\Omega$		4.2		
		$V_{CC}=5V\pm 0.5 V$	$C_L=50pF, R_L=500\Omega$		3.2		
Power dissipation capacitance	$C_{pd}$	No load			18		pF

(1) All unused inputs of the device must be held at  $V_{CC}$  or GND to ensure proper device operation.

(2) This parameter is ensured by design and/or characterization and is not tested in production.

(3) Typical values represent the most likely parametric norm as determined at the time of characterization. Actual typical values may vary over time and will also depend on the application and configuration.



## 10 Parameter Measurement Information

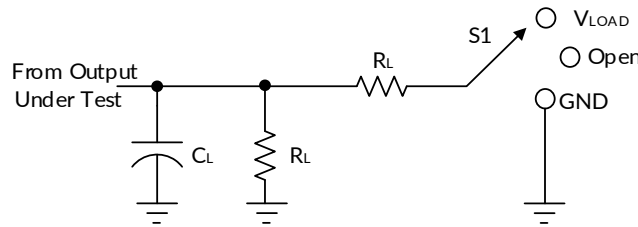

TEST	S1
$t_{PLH}/t_{PHL}$	Open
$t_{PLZ}/t_{PZL}$	$V_{LOAD}$
$t_{PHZ}/t_{PZH}$	GND

$V_{CC}$	INPUTS		$V_M$	$V_{LOAD}$	$C_L$	$R_L$	$V_{\Delta}$
	$V_I$	$t_r/t_f$					
$2.0V \pm 0.2V$	$V_{CC}$	$\leq 2ns$	$V_{CC}/2$	$2 \times V_{CC}$	30pF	500Ω	0.15V
$3.3V \pm 0.3V$	$V_{CC}$	$\leq 2.5ns$	$V_{CC}/2$	$2 \times V_{CC}$	50pF	500Ω	0.3V
$5V \pm 0.5V$	$V_{CC}$	$\leq 2.5ns$	$V_{CC}/2$	$2 \times V_{CC}$	50pF	500Ω	0.3V

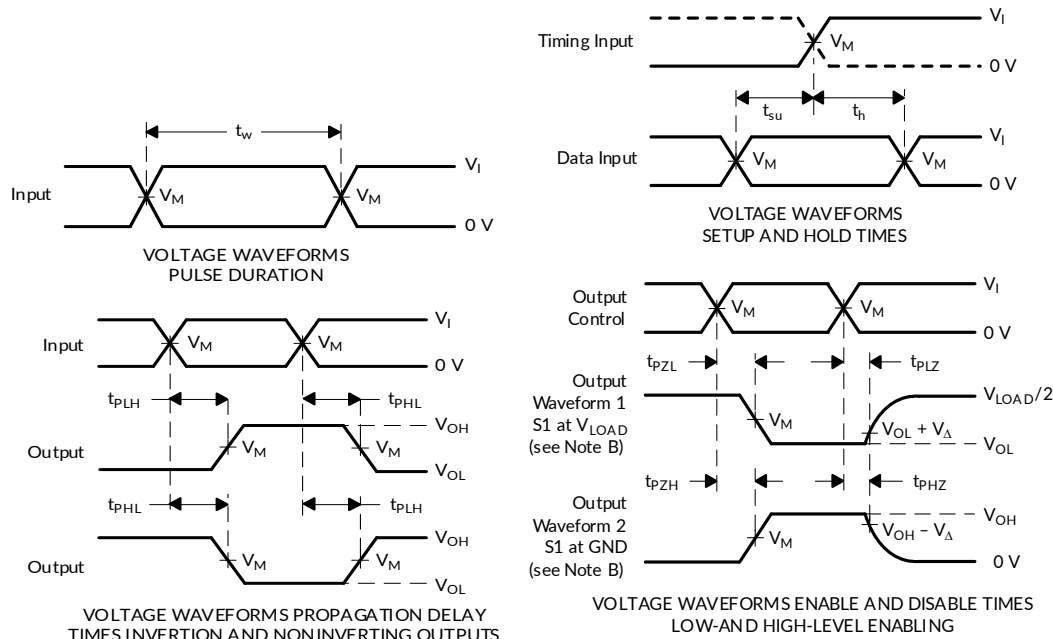

- NOTES: A.  $C_L$  includes probe and jig capacitance.  
 B. Waveform 1 is for an output with internal conditions such that the output is low, except when disabled by the output control. Waveform 2 is for an output with internal conditions such that the output is high, except when disabled by the output control.  
 C. All input pulses are supplied by generators having the following characteristics:  $PRR \leq 10 \text{ MHz}$ ,  $Z_0 = 50\Omega$ .  
 D. The outputs are measured one at a time, with one transition per measurement.  
 E.  $t_{PLZ}$  and  $t_{PHZ}$  are the same as  $t_{dis}$ .  
 F.  $t_{PZL}$  and  $t_{PZH}$  are the same as  $t_{en}$ .  
 G.  $t_{PLH}$  and  $t_{PHL}$  are the same as  $t_{pd}$ .  
 H. All parameters and waveforms are not applicable to all devices.

**Figure 1. Load Circuit and Voltage Waveforms**

# 11 PACKAGE OUTLINE DIMENSIONS

## SOT23-5 <sup>(3)</sup>

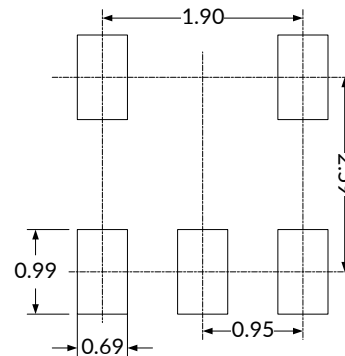
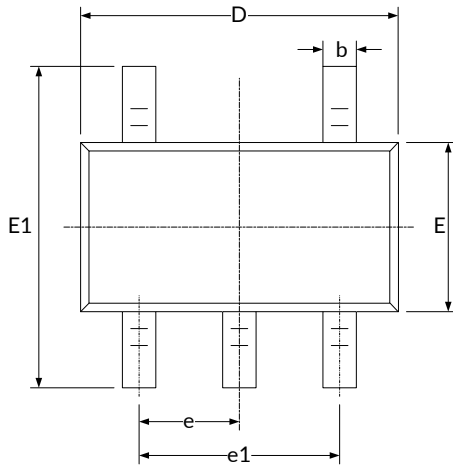

RECOMMENDED LAND PATTERN (Unit: mm)

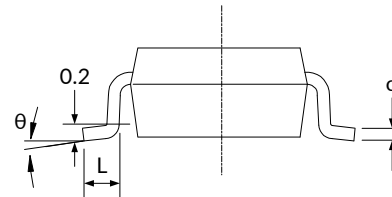
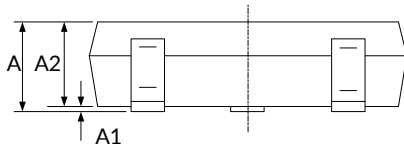

Symbol	Dimensions In Millimeters		Dimensions In Inches	
	Min	Max	Min	Max
A <sup>(1)</sup>	1.050	1.250	0.041	0.049
A1	0.000	0.100	0.000	0.004
A2	1.050	1.150	0.041	0.045
b	0.300	0.500	0.012	0.020
c	0.100	0.200	0.004	0.008
D <sup>(1)</sup>	2.820	3.020	0.111	0.119
E <sup>(1)</sup>	1.500	1.700	0.059	0.067
E1	2.650	2.950	0.104	0.116
e	0.950(BSC) <sup>(2)</sup>		0.037(BSC) <sup>(2)</sup>	
e1	1.800	2.000	0.071	0.079
L	0.300	0.600	0.012	0.024
$\theta$	0°	8°	0°	8°

NOTE:

1. Plastic or metal protrusions of 0.15mm maximum per side are not included.
2. BSC (Basic Spacing between Centers), "Basic" spacing is nominal.
3. This drawing is subject to change without notice.

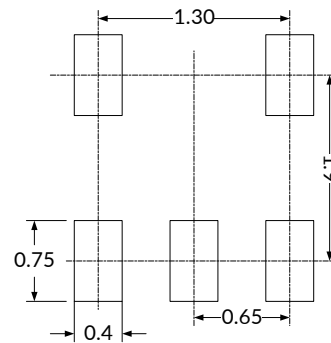
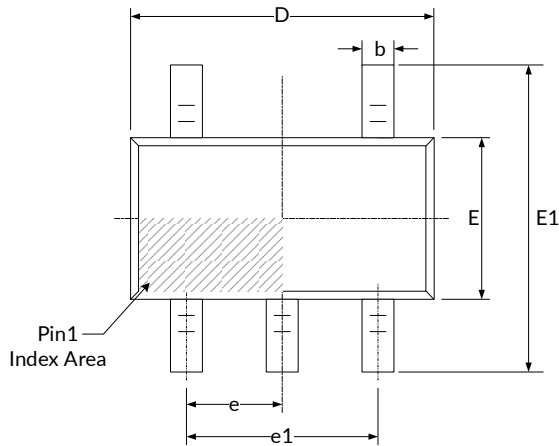
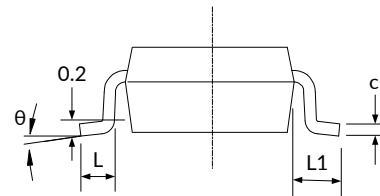
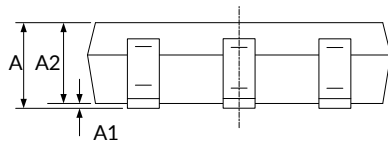
**SC70-5 (3)**

**RECOMMENDED LAND PATTERN (Unit: mm)**

Symbol	Dimensions In Millimeters		Dimensions In Inches	
	Min	Max	Min	Max
A <sup>(1)</sup>	0.900	1.100	0.035	0.043
A1	0.000	0.100	0.000	0.004
A2	0.900	1.000	0.035	0.039
b	0.150	0.350	0.006	0.014
c	0.080	0.150	0.003	0.006
D <sup>(1)</sup>	2.000	2.200	0.079	0.087
E <sup>(1)</sup>	1.150	1.350	0.045	0.053
E1	2.150	2.450	0.085	0.096
e	0.650(BSC) <sup>(2)</sup>		0.026(BSC) <sup>(2)</sup>	
e1	1.300(BSC) <sup>(2)</sup>		0.051(BSC) <sup>(2)</sup>	
L	0.260	0.460	0.010	0.018
L1	0.525		0.021	
θ	0°	8°	0°	8°

**NOTE:**

1. Plastic or metal protrusions of 0.15mm maximum per side are not included.
2. BSC (Basic Spacing between Centers), "Basic" spacing is nominal.
3. This drawing is subject to change without notice.

## 12 TAPE AND REEL INFORMATION

### REEL DIMENSIONS

### TAPE DIMENSION

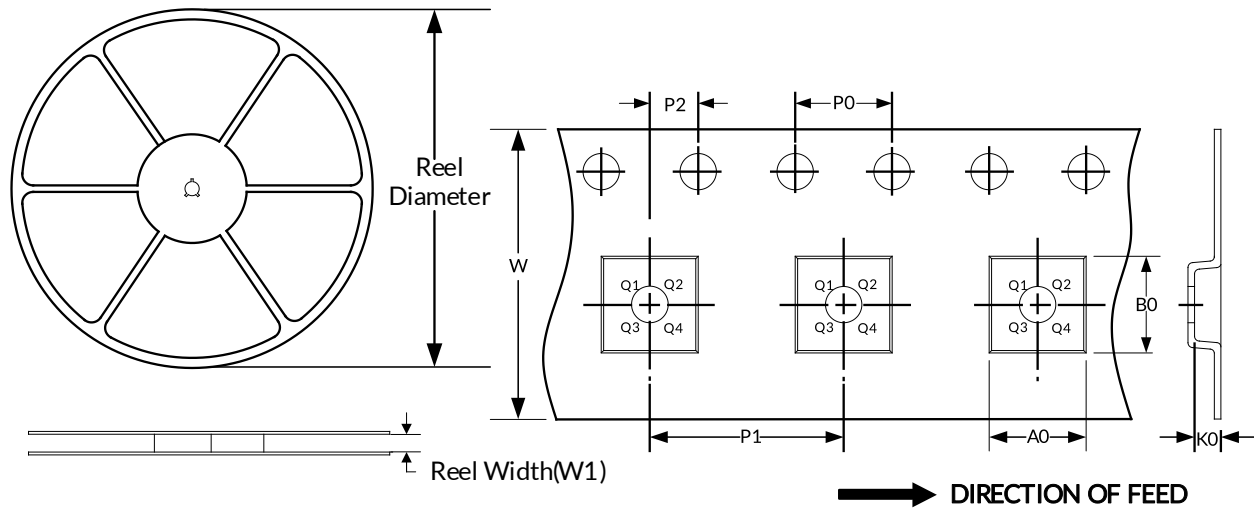

NOTE: The picture is only for reference. Please make the object as the standard.

### KEY PARAMETER LIST OF TAPE AND REEL

Package Type	Reel Diameter	Reel Width(mm)	A0 (mm)	B0 (mm)	K0 (mm)	P0 (mm)	P1 (mm)	P2 (mm)	W (mm)	Pin1 Quadrant
SC70-5	7"	9.5	2.25	2.55	1.20	4.0	4.0	2.0	8.0	Q3
SOT23-5	7"	9.5	3.20	3.20	1.40	4.0	4.0	2.0	8.0	Q3

NOTE:

1. All dimensions are nominal.
2. Plastic or metal protrusions of 0.15mm maximum per side are not included.

## **IMPORTANT NOTICE AND DISCLAIMER**

Jiangsu Runic Technology Co., Ltd. will accurately and reliably provide technical and reliability data (including data sheets), design resources (including reference designs), application or other design advice, WEB tools, safety information and other resources, without warranty of any defect, and will not make any express or implied warranty, including but not limited to the warranty of merchantability Implied warranty that it is suitable for a specific purpose or does not infringe the intellectual property rights of any third party.

These resources are intended for skilled developers designing with Runic products You will be solely responsible for: (1) Selecting the appropriate products for your application; (2) Designing, validating and testing your application; (3) Ensuring your application meets applicable standards and any other safety, security or other requirements; (4) Runic and the Runic logo are registered trademarks of Runic Incorporated. All trademarks are the property of their respective owners; (5) For change details, review the revision history included in any revised document. The resources are subject to change without notice. Our company will not be liable for the use of this product and the infringement of patents or third-party intellectual property rights due to its use.