

# Nano-Power, RRIO, 2.5V, Push-Pull Output Comparator with Voltage Reference

## 1 FEATURES

- **Low Supply Current:** 3.5 $\mu$ A(TYP) at Vs=2.5V
- **Supply Range:** +2.5V to +5.5V
- **Integrated Voltage Reference:** 1.2V
- **Low Input Offset Voltage:** Vos(max) = 3.5mV at Vs=5V
- **Rail-to-Rail Input**
- **Push-Pull Output**
- **Operating Temperature Range:** -40°C to +125°C
- **Micro SIZE PACKAGES:** SOT23-6, DFN1.6x1.6-6L

## 2 APPLICATIONS

- **RC TIMERS**
- **MULTIVIBRATORS**
- **WINDOW DETECTORS**
- **SYSTEM MONITORING**
- **SENSOR SYSTEMS:** Smoke Detectors, Light Sensors, Alarms

## 3 DESCRIPTIONS

The RS8912 is a push-pull output comparator. It features an uncommitted on-chip voltage reference and have low quiescent current, input common-mode range 100mV beyond the supply rails, and single-supply operation from 2.5V to 5.5V. The integrated 1.2V series voltage reference offers low 60 $\mu$ V/°C drift, is stable with up to 10nF capacitive load, and can provide up to 310uA (TYP) of output current.

Featuring a push-pull output stage, the RS8912 allows for operation with absolute minimum power consumption when driving any capacitive or resistive load.

The RS8912 is available in Green SOT23-6 and DFN1.6x1.6-6L package, it is specified at the full temperature range of -40°C to +125°C.

**Device Information <sup>(1)</sup>**

PART NUMBER	PACKAGE	BODY SIZE (NOM)
RS8912	SOT23-6	1.60mmx2.92mm
	DFN1.6x1.6-6L	1.60mmx1.60mm

(1) For all available packages, see the orderable addendum at the end of the data sheet.

## Table of Contents

<b>1 FEATURES</b> .....	1
<b>2 APPLICATIONS</b> .....	1
<b>3 DESCRIPTIONS</b> .....	1
<b>4 Revision History</b> .....	3
<b>5 PACKAGE/ORDERING INFORMATION</b> <sup>(1)</sup> .....	4
<b>6 Pin Configuration and Functions (Top View)</b> .....	5
<b>7 SPECIFICATIONS</b> .....	6
7.1 Absolute Maximum Ratings .....	6
7.2 ESD Ratings .....	6
7.3 Recommended Operating Conditions .....	6
7.4 Thermal Information:RS8912 .....	7
7.5 ELECTRICAL CHARACTERISTICS: $V_S=2.5V$ .....	8
7.6 ELECTRICAL CHARACTERISTICS: $V_S=5V$ .....	9
7.7 TYPICAL CHARACTERISTICS .....	10
<b>8 PACKAGE OUTLINE DIMENSIONS</b> .....	13
<b>9 TAPE AND REEL INFORMATION</b> .....	15

## 4 Revision History

Note: Page numbers for previous revisions may differ from page numbers in the current version.

VERSION	Change Date	Change Item
A.3	2022/01/25	<ol style="list-style-type: none"><li>1. Delete the second remark in the Absolute Maximum Ratings in Page 4@A.2 Version.</li><li>2. Added TAPE AND REEL INFORMATION</li></ol>
A.4	2022/07/04	<ol style="list-style-type: none"><li>1. Update Operating Temperature Range: -40°C to +125°C</li><li>2. Update ELECTRICAL CHARACTERISTICS and TYPICAL CHARACTERISTICS</li><li>3. Update Supply Range: +2.5V to +5.5V</li></ol>

**5 PACKAGE/ORDERING INFORMATION <sup>(1)</sup>**

Orderable Device	Package Type	Pin	Channel	Op Temp(°C)	Device Marking <sup>(2)</sup>	Package Qty
RS8912XH	SOT23-6	6	1	-40°C ~125°C	8912	Tape and Reel,3000
RS8912XUTDL6	DFN1.6×1.6-6L	6	1	-40°C ~125°C	8912	Tape and Reel,3000

## NOTE:

- (1) This information is the most current data available for the designated devices. This data is subject to change without notice and revision of this document. For browser-based versions of this data sheet, refer to the right-hand navigation.
- (2) There may be additional marking, which relates to the lot trace code information(data code and vendor code), the logo or the environmental category on the device.

## 6 Pin Configuration and Functions (Top View)

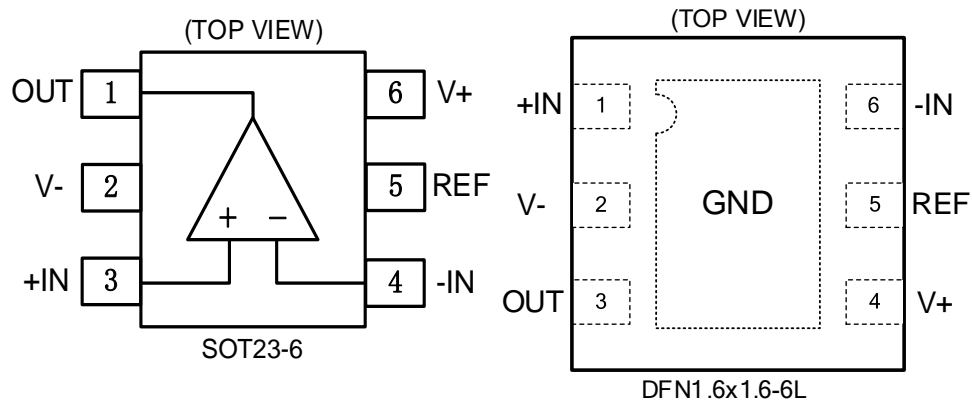

### Pin Description

NAME	PIN		I/O <sup>(1)</sup>	DESCRIPTION
	SOT23-6	DFN1.6x1.6-6L		
OUT	1	3	O	Output
V-	2	2	P	Negative (lowest) power supply
+IN	3	1	I	Noninverting input
-IN	4	6	I	Inverting input
REF	5	5	O	Voltage Reference
V+	6	4	P	Positive (highest) power supply

(1) I=Input, O=Output, P=Power

## 7 SPECIFICATIONS

### 7.1 Absolute Maximum Ratings

Over operating free-air temperature range (unless otherwise noted) <sup>(1)</sup>

		MIN	MAX	UNIT
Voltage	Supply, $V_S=(V+) - (V-)$		7	V
	Input pin (IN+, IN-) <sup>(2)</sup>	(V-)-0.5	(V+) +0.5	
	Signal output pin <sup>(3)</sup>	(V-)-0.5	(V+) +0.5	
Current	Signal input pin (IN+, IN-) <sup>(2)</sup>	-10	10	mA
	Signal output pin <sup>(3)</sup>	-10	10	mA
	Output short-circuit <sup>(4)</sup>	Continuous		
Temperature	Operating range, $T_A$	-40	125	°C
	Junction, $T_J$ <sup>(5)</sup>	-40	150	
	Storage, $T_{stg}$	-65	150	

(1) Stresses above these ratings may cause permanent damage. Exposure to absolute maximum conditions for extended periods may degrade device reliability. These are stress ratings only, and functional operation of the device at these or any other conditions beyond those specified is not implied.

(2) Input terminals are diode-clamped to the power-supply rails. Input signals that can swing more than 0.5V beyond the supply rails should be current-limited to  $\pm 10\text{mA}$  or less.

(3) Output terminals are diode-clamped to the power-supply rails. Output signals that can swing more than 0.5V beyond the supply rails should be current-limited to  $\pm 10\text{mA}$  or less.

(4) Short-circuit to ground, one amplifier per package.

(5) The maximum power dissipation is a function of  $T_{J(\text{MAX})}$ ,  $R_{\theta JA}$ , and  $T_A$ . The maximum allowable power dissipation at any ambient temperature is  $P_D = (T_{J(\text{MAX})} - T_A) / R_{\theta JA}$ . All numbers apply for packages soldered directly onto a PCB.

### 7.2 ESD Ratings

The following ESD information is provided for handling of ESD-sensitive devices in an ESD protected area only.

			VALUE	UNIT
$V_{(\text{ESD})}$	Electrostatic discharge	Human-body model (HBM), per ANSI/ESDA/JEDEC JS-001 <sup>(1)</sup>	$\pm 3000$	V
		Machine Model (MM)	$\pm 200$	

(1) JEDEC document JEP155 states that 500 V HBM allows safe manufacturing with a standard ESD control process.



### ESD SENSITIVITY CAUTION

ESD damage can range from subtle performance degradation to complete device failure. Precision integrated circuits may be more susceptible to damage because very small parametric changes could cause the device not to meet its published specifications.

### 7.3 Recommended Operating Conditions

Over operating free-air temperature range (unless otherwise noted)

		MIN	NOM	MAX	UNIT
Supply voltage, $V_S=(V+) - (V-)$	Single-supply	2.5		5.5	V
	Dual-supply	$\pm 1.25$		$\pm 2.75$	

**7.4 Thermal Information:RS8912**

THERMAL METRIC <sup>(1)</sup>		RS8912	UNIT
		6PINS	
		SOT23-6	
R <sub>θJA</sub>	Junction-to-ambient thermal resistance	214.7	°C/W
R <sub>θJC(top)</sub>	Junction-to-case(top) thermal resistance	127.1	°C/W
R <sub>θJB</sub>	Junction-to-board thermal resistance	60.0	°C/W
Ψ <sub>JT</sub>	Junction-to-top characterization parameter	33.4	°C/W
Ψ <sub>JB</sub>	Junction-to-board characterization parameter	59.8	°C/W
R <sub>θJC(bot)</sub>	Junction-to-case(bottom) thermal resistance	N/A	°C/W

(1) Thermal resistance varies with operating conditions.

## 7.5 ELECTRICAL CHARACTERISTICS: $V_S=2.5V$

(At  $T_A = +25^\circ C$ ,  $V_+ = 2.5V$ ,  $V_- = 0V$ ,  $V_{CM} = V_S/2$ , unless otherwise noted.)

PARAMETER		CONDITIONS	RS8912			UNITS
			MIN	TYP	MAX	
<b>POWER SUPPLY</b>						
$V_S$	Operating Voltage Range		2.5		5.5	V
$I_Q$	Quiescent Current			3.5	8	$\mu A$
PSRR	Power-Supply Rejection Ratio	$V_S = 2.5V$ to $5.5V$ , $V_{CM} = (V) + 0.5V$		70		dB
<b>INPUT</b>						
$V_{OS}$	Input Offset Voltage	$V_{CM} = 0V$		1	5	mV
		$V_{CM} = 2.5V$		1	5	
$\Delta V_{OS}/\Delta T$	Input Offset Voltage Drift	$V_{CM} = V_S/2$ , $-40^\circ C \leq T_A \leq 125^\circ C$		2		$\mu V/^\circ C$
$I_B$	Input Bias Current			1	10	pA
$V_{CM}$	Common-Mode Voltage Range	$T_A = -40^\circ C$ to $125^\circ C$	(V $-$ )-0.1		(V $+$ )+0.1	V
CMRR	Common-Mode Rejection Ratio	$V_{CM} = -0.1V$ to $2.6V$		70		dB
<b>OUTPUT</b>						
$V_{OH}$	Output Swing From Upper Rail	$I_O = 25\mu A$	2.410	2.440		V
		$I_O = 95\mu A$	2.186	2.277		
$V_{OL}$	Output Swing From Lower Rail	$I_O = 25\mu A$		55	80	mV
		$I_O = 95\mu A$		215	289	
$I_{SC}$	Short Circuit Sink Current	$V_S = \pm 1.25V$ , $V_{OUT} = 0V$		-0.6	-0.3	mA
	Short Circuit Source Current	$V_S = \pm 1.25V$ , $V_{OUT} = 0V$	0.3	0.6		mA
<b>SWITCHING</b>						
$T_{PHL}$	Propagation Delay H To L	Overdrive = 20 mV		45		$\mu s$
		Overdrive = 100 mV		15		
$T_{PLH}$	Propagation Delay L To H	Overdrive = 20 mV		40		
		Overdrive = 100 mV		20		
$T_R$	Rise Time	Overdrive = 100 mV		30		$\mu s$
$T_F$	Fall Time	Overdrive = 100 mV		30		$\mu s$
	Noise of $V_{REF}$	$f = 0.1Hz$ to $10Hz$		20		$\mu V_{RMS}$
<b>VOLTAGE REFERENCE</b>						
$V_{REF}$	Reference Voltage	$I_{REF} = 0mA$	1.176	1.200	1.224	V
	Reference Voltage Drift			60		$\mu V/^\circ C$
	Reference Output Current (Source)		80	110		$\mu A$



## 7.6 ELECTRICAL CHARACTERISTICS: $V_S=5V$

(At  $T_A = +25^\circ C$ ,  $V_+=5V$ ,  $V_-=0V$ ,  $V_{CM}=V_S/2$ , unless otherwise noted.)

PARAMETER		CONDITIONS	RS8912			UNITS
			MIN	TYP	MAX	
<b>POWER SUPPLY</b>						
$V_S$	Operating Voltage Range		2.5		5.5	V
$I_Q$	Quiescent Current			4.85	10	$\mu A$
PSRR	Power-Supply Rejection Ratio	$V_S=2.5V$ to $5.5V$ , $V_{CM}=(V_+)+0.5V$		70		dB
<b>INPUT</b>						
$V_{OS}$	Input Offset Voltage	$V_{CM} = 0V$		1	3.5	mV
		$V_{CM} = 5V$		1	3.5	
$\Delta V_{OS}/\Delta T$	Input Offset Voltage Drift	$V_{CM} = V_S/2$ , $-40^\circ C \leq T_A \leq 125^\circ C$		2		$\mu V/^\circ C$
$I_B$	Input Bias Current			1	10	pA
$V_{CM}$	Common-Mode Voltage Range	$T_A = -40^\circ C$ to $125^\circ C$	$(V_-)-0.1$		$(V_+)+0.1$	V
CMRR	Common-Mode Rejection Ratio	$V_{CM} = -0.1V$ to $5.1V$		70		dB
<b>OUTPUT</b>						
$V_{OH}$	Output Swing From Upper Rail	$I_O=25\mu A$	4.915	4.935		V
		$I_O=95\mu A$	4.720	4.785		
$V_{OL}$	Output Swing From Lower Rail	$I_O=25\mu A$		55	72	mV
		$I_O=95\mu A$		215	280	
$I_{SC}$	Short Circuit Sink Current	$V_S=\pm 2.5V$ , $V_{OUT}=0V$		-1.1	-0.9	mA
	Short Circuit Source Current	$V_S=\pm 2.5V$ , $V_{OUT}=0V$	0.9	1.1		mA
<b>SWITCHING</b>						
$T_{PHL}$	Propagation Delay H To L	Overdrive = 20 mV		25		$\mu s$
		Overdrive = 100 mV		10		
$T_{PLH}$	Propagation Delay L To H	Overdrive = 20 mV		20		
		Overdrive = 100 mV		10		
$T_R$	Rise Time	Overdrive = 100 mV		12		$\mu s$
$T_F$	Fall Time	Overdrive = 100 mV		12		$\mu s$
	Noise of $V_{REF}$	$f=0.1Hz$ to $10Hz$		20		$\mu V_{RMS}$
<b>VOLTAGE REFERENCE</b>						
$V_{REF}$	Reference Voltage	$I_{REF}=0mA$	1.176	1.200	1.224	V
	Reference Voltage Drift			50		$\mu V/^\circ C$
	Reference Output Current (Source)		200	310		$\mu A$

### 7.7 TYPICAL CHARACTERISTICS

NOTE: The graphs and tables provided following this note are a statistical summary based on a limited number of samples and are provided for informational purposes only.

At  $T_A = +25^\circ\text{C}$ ,  $V_S=5\text{V}$ ,  $V_{CM} = V_S/2$ ,  $C_L=15\text{pF}$  unless otherwise noted.

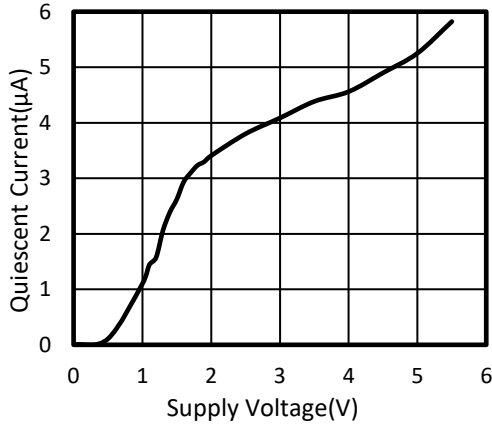

Figure 1. Supply Voltage vs Quiescent Current

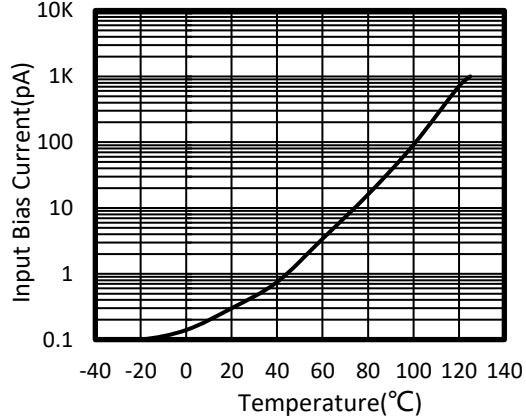

Figure 2. INPUT BIAS CURRENT vs TEMPERATURE

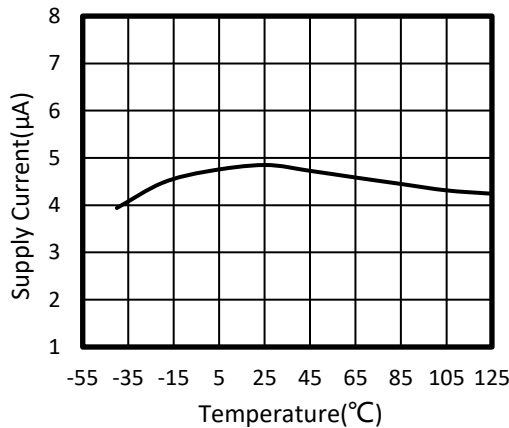

Figure 3. Supply Current vs Temperature

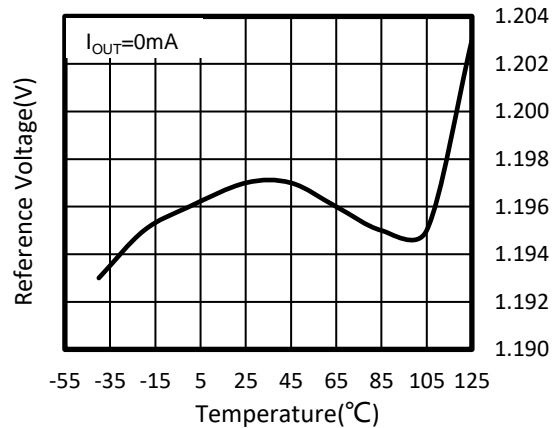

Figure 4. Reference Voltage vs Temperature

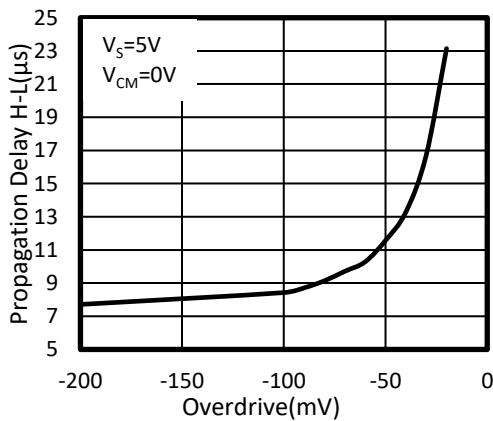

Figure 5. Propagation Delay vs Overdrive

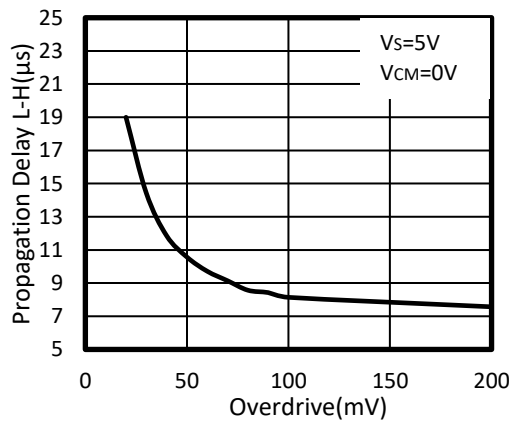

Figure 6. Propagation Delay vs Overdrive

## TYPICAL CHARACTERISTICS

NOTE: The graphs and tables provided following this note are a statistical summary based on a limited number of samples and are provided for informational purposes only.

At  $T_A = +25^\circ\text{C}$ ,  $V_S=5\text{V}$ ,  $V_{CM} = V_S/2$ ,  $C_L=15\text{pF}$  unless otherwise noted.

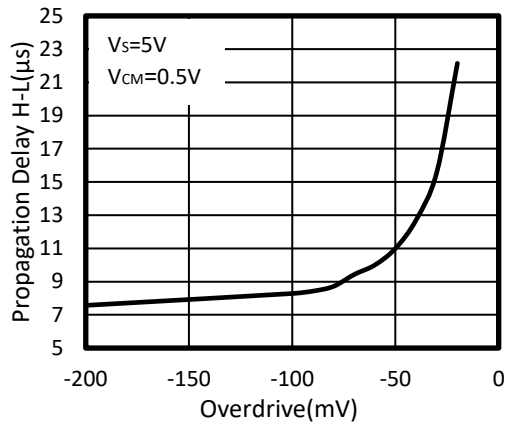

Figure 7. Propagation Delay vs Overdrive

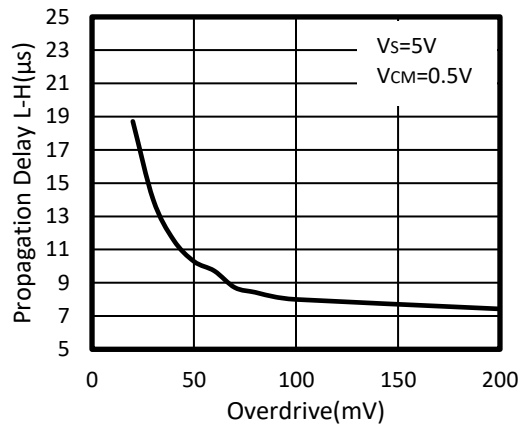

Figure 8. Propagation Delay vs Overdrive

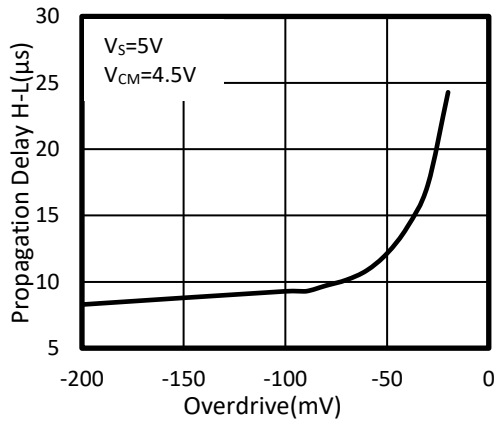

Figure 9. Propagation Delay vs Overdrive

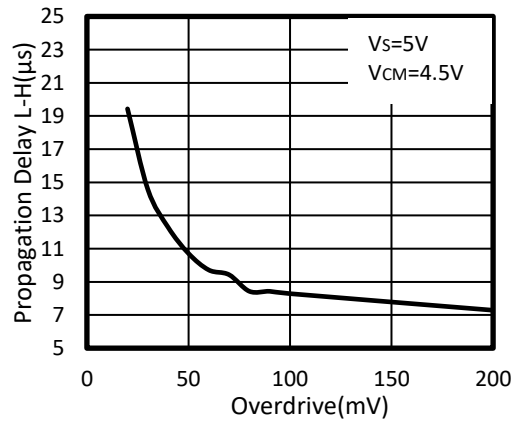

Figure 10. Propagation Delay vs Overdrive

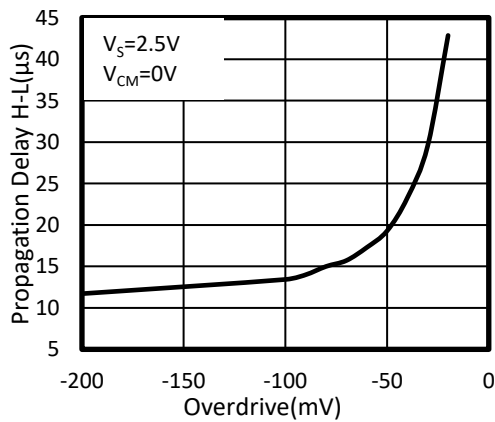

Figure 11. Propagation Delay vs Overdrive

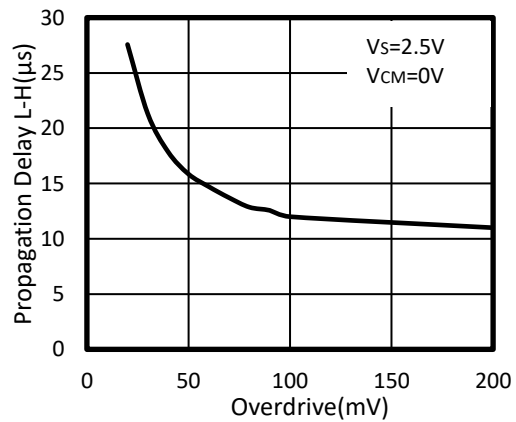

Figure 12. Propagation Delay vs Overdrive

## TYPICAL CHARACTERISTICS

NOTE: The graphs and tables provided following this note are a statistical summary based on a limited number of samples and are provided for informational purposes only.

At  $T_A = +25^\circ\text{C}$ ,  $V_S=5\text{V}$ ,  $V_{CM} = V_S/2$ ,  $C_L=15\text{pF}$  unless otherwise noted.

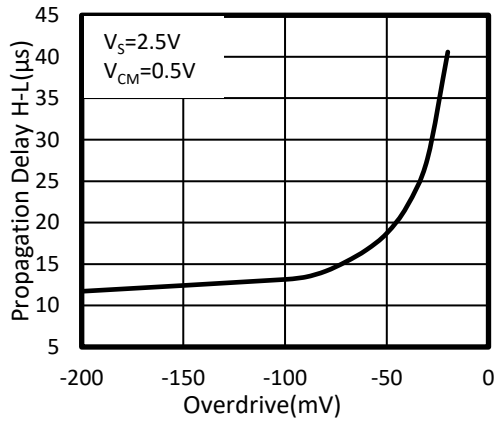

Figure 13. Propagation Delay vs Overdrive

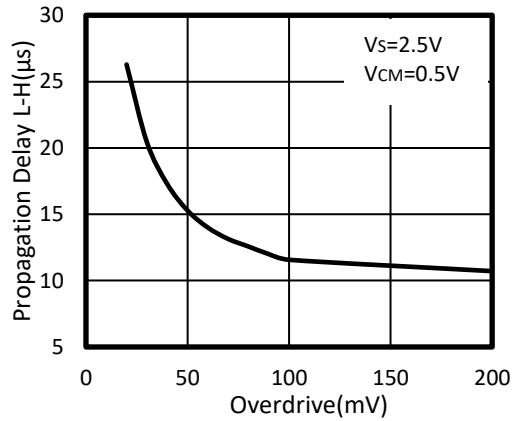

Figure 14. Propagation Delay vs Overdrive

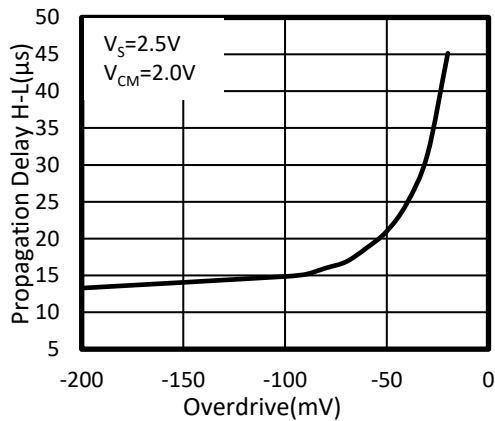

Figure 15. Propagation Delay vs Overdrive

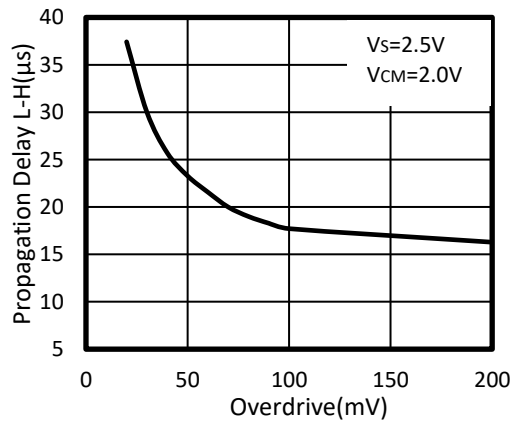
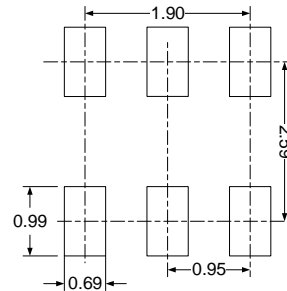
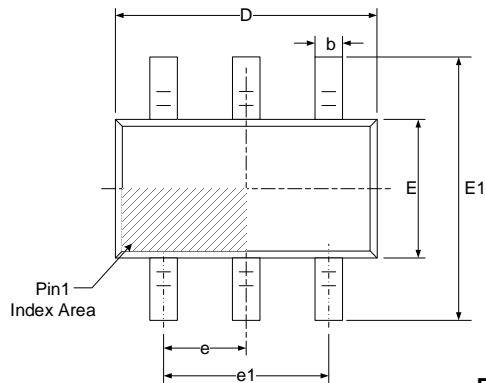

Figure 16. Propagation Delay vs Overdrive

# 8 PACKAGE OUTLINE DIMENSIONS

## SOT23-6



**RECOMMENDED LAND PATTERN (Unit: mm)**

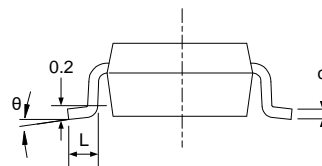
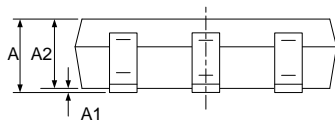

Symbol	Dimensions In Millimeters		Dimensions In Inches	
	Min	Max	Min	Max
A	1.050	1.250	0.041	0.049
A1	0.000	0.100	0.000	0.004
A2	1.050	1.150	0.041	0.045
b	0.300	0.500	0.012	0.020
c	0.100	0.200	0.004	0.008
D	2.820	3.020	0.111	0.119
E	1.500	1.700	0.059	0.067
E1	2.650	2.950	0.104	0.116
e	0.950(BSC)		0.037(BSC)	
e1	1.800	2.000	0.071	0.079
L	0.300	0.600	0.012	0.024
$\theta$	0°	8°	0°	8°

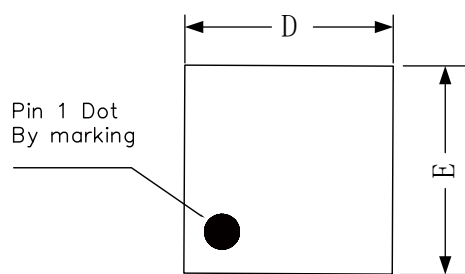
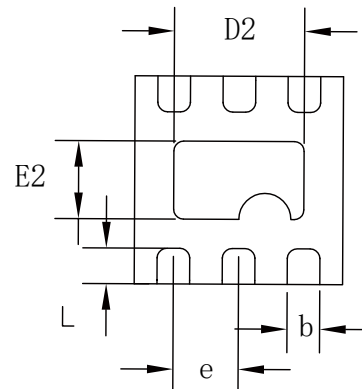
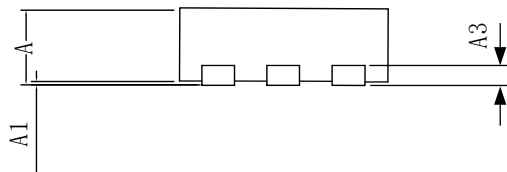
**DFN1.6x1.6-6L**

**TOP VIEW**

**BOTTOM VIEW**

**SIDE VIEW**

Symbol	Dimensions In Millimeters		Dimensions In Inches	
	Min	Max	Min	Max
A	0.500	0.600	0.020	0.024
A1	0.000	0.050	0.000	0.002
A3	0.150 REF		0.006 REF	
D	1.550	1.650	0.061	0.065
E	1.550	1.650	0.061	0.065
D2	0.900	1.050	0.035	0.041
E2	0.500	0.650	0.020	0.025
L	0.200	0.300	0.008	0.012
b	0.200	0.300	0.008	0.012
e	0.500 BSC		0.020 BSC	

**NOTE:**

- A. All linear dimension is in millimeters.
- B. This drawing is subject to change without notice.
- C. Body dimensions do not include mold flash or protrusion. Mold flash and protrusion shall not exceed 0.15 per side.
- D. BSC: Basic Dimension. Theoretically exact value shown without tolerances.
- E. REF: Reference Dimension, usually without tolerance, for information purposes only.

## 9 TAPE AND REEL INFORMATION

### REEL DIMENSIONS

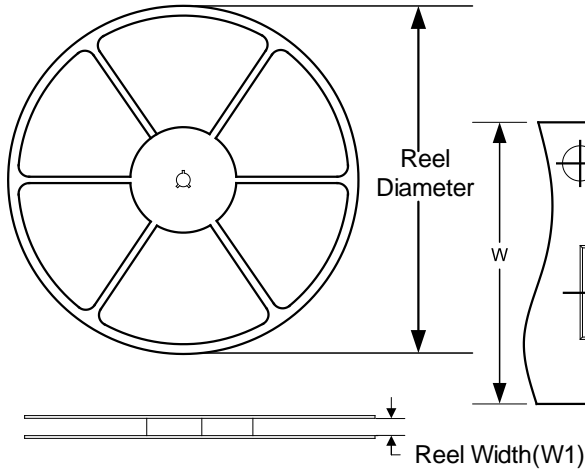

### TAPE DIMENSION

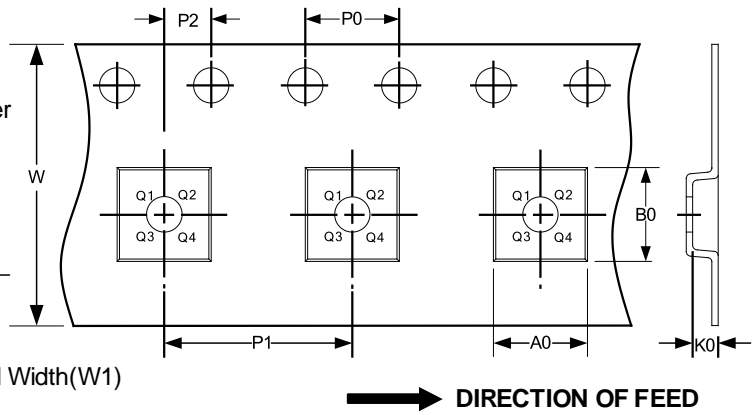

NOTE: The picture is only for reference. Please make the object as the standard.

### KEY PARAMETER LIST OF TAPE AND REEL

Package Type	Reel Diameter	Reel Width(mm)	A0 (mm)	B0 (mm)	K0 (mm)	P0 (mm)	P1 (mm)	P2 (mm)	W (mm)	Pin1 Quadrant
SOT23-6	7"	9.5	3.17	3.23	1.37	4.0	4.0	2.0	8.0	Q3
DFN1.6×1.6-6L	7"	9.5	1.86	1.90	0.88	4.0	4.0	2.0	8.0	Q1

NOTE:

1. All dimensions are nominal.
2. Plastic or metal protrusions of 0.15mm maximum per side are not included.

## IMPORTANT NOTICE AND DISCLAIMER

Jiangsu Runic Technology Co., Ltd. will accurately and reliably provide technical and reliability data (including data sheets), design resources (including reference designs), application or other design advice, WEB tools, safety information and other resources, without warranty of any defect, and will not make any express or implied warranty, including but not limited to the warranty of merchantability Implied warranty that it is suitable for a specific purpose or does not infringe the intellectual property rights of any third party.

These resources are intended for skilled developers designing with Runic products You will be solely responsible for: (1) Selecting the appropriate products for your application; (2) Designing, validating and testing your application; (3) Ensuring your application meets applicable standards and any other safety, security or other requirements; (4) Runic and the Runic logo are registered trademarks of Runic Incorporated. All trademarks are the property of their respective owners; (5) For change details, review the revision history included in any revised document. The resources are subject to change without notice. Our company will not be liable for the use of this product and the infringement of patents or third-party intellectual property rights due to its use.